

Machine-Type Communication for *Maritime* Internet of Things: A Design

Michael Mao Wang¹, Jingjing Zhang, and Xiaohu You², *Fellow, IEEE*

Abstract—This paper presents a *maritime machine-type communication (MTC) concept dedicated to the maritime Internet of Things (IoT)*. It first outlines the unique maritime MTC requirements on the ubiquity, continuity, heterogeneity, simplicity, interoperability, and scalability for maritime IoT applications and services. It then addresses these requirements through a concrete maritime MTC system design, based on the international VHF maritime mobile spectrum recently allocated for maritime MTC by ITU to enable maritime IoT under the name *e-Navigation*. Finally, it highlights the potential pitfalls to avoid in future development and standardization of the maritime MTC technology.

Index Terms—Maritime machine-type communication, maritime Internet of Things, *e-navigation*, maritime mobile VHF radio spectrum, VHF data exchange system (VDES).

I. INTRODUCTION

THE OCEANS cover more than 70 percent of the surface of the earth. This expansive marine area represents a prime international domain for maritime transportation, of which international freight shipping is responsible for the carriage of about 90 percent of world trade. This reality creates a new paradigm for the Internet of Things (IoT).

A similar concept was initially developed to modernize the maritime industries by the United Nations chartered International Maritime Organization (IMO) under the name *e-Navigation* [1]. This concept is further extended and technically formalized to a fully-fledged maritime IoT framework in [2], [3], and [4], under which all vessels and maritime equipment, i.e., the maritime “things” are interconnected through a *unified* machine-type communication (MTC) system for undisrupted maritime services worldwide.

Just as for any other IoT application, MTC technology is the key to maritime IoT. In order to enable maritime IoT, there is a need for establishing the communication between vessels and shore stations as well as among vessels to support various types of maritime services. Although the infancy and youth of radio communication were mainly linked to

maritime applications, advancements in maritime communication technologies are severely lagging behind their land counterparts. While wireless communication technologies have undergone revolutionary developments and breakthroughs [5], maritime communication still has been mostly relying on voice communications. More efficient communication solutions are sorely required for the transfer of more maritime information, particularly in adverse conditions, allowing timely decision making, and effective mitigation of the remoteness of the maritime activities and operations that will lead to safer and more efficient voyages. Only in recent years, maritime communication is slowly gaining momentum in modernizing maritime mobile services [6]. In particular, The International Telecommunication Union (ITU) introduced the first maritime data transmission system Digital Selective Calling in the VHF maritime mobile band to help ensure the calling and distress communications [7]. Primarily for vessel identification, collision avoidance, and in support of vessel traffic information service, ITU introduced another VHF data transmission system, coined Automatic Identification System (AIS) [8]. During the last decade, IMO has popularized AIS for the exchange of navigational data between ships, as well as between ships and shore, to improve the situation awareness over voice, sight, and radar [9], [10].

Progresses in the maritime domain for the modernization and mobilization of maritime-related businesses continue to challenge the legacy maritime communication systems, which have gradually shown their incompetence in meeting the ever-increasing demand from maritime services in terms of ubiquity, continuity, and heterogeneity [11], [12]. To respond to this increased data transfer and improve maritime safety and efficiency in the growing maritime environment, ITU recently allocated radio spectrum in the VHF maritime mobile band designated to maritime IoT [4]. IMO and the International Association of Marine Aids to Navigation and Lighthouse Authorities (IALA) have been leading the effort to establish a maritime communication system to enable *e-Navigation* [13]–[18], nonetheless, struggling to meet the challenging maritime MTC requirements. As such, this paper intends to help fill this gap by proposing a comprehensive maritime MTC architecture and a concrete design under this architecture, tailored for the VHF maritime mobile communication spectrum.

As outlined in Fig. 1, the remainder of this paper is organized as follows. Section II identifies the typical maritime IoT applications and the requirements and challenges for maritime MTC. Section III overviews the key components associated

Manuscript received November 25, 2019; revised April 5, 2020 and May 26, 2020; accepted July 8, 2020. Date of publication August 10, 2020; date of current version November 20, 2020. This work was supported in part by the National Natural Science Foundation of China under Grant 61771128. (*Corresponding author: Michael Mao Wang.*)

Michael Mao Wang and Xiaohu You are with the School of Information Science and Engineering, Southeast University, Nanjing 210096, China, and also with the National Mobile Communications Research Laboratory, Southeast University, Nanjing 211111, China (e-mail: wangmao@seu.edu.cn).

Jingjing Zhang is with the School of Internet of Things, Nanjing University of Posts and Telecommunications, Nanjing 210023, China.

Digital Object Identifier 10.1109/COMST.2020.3015694

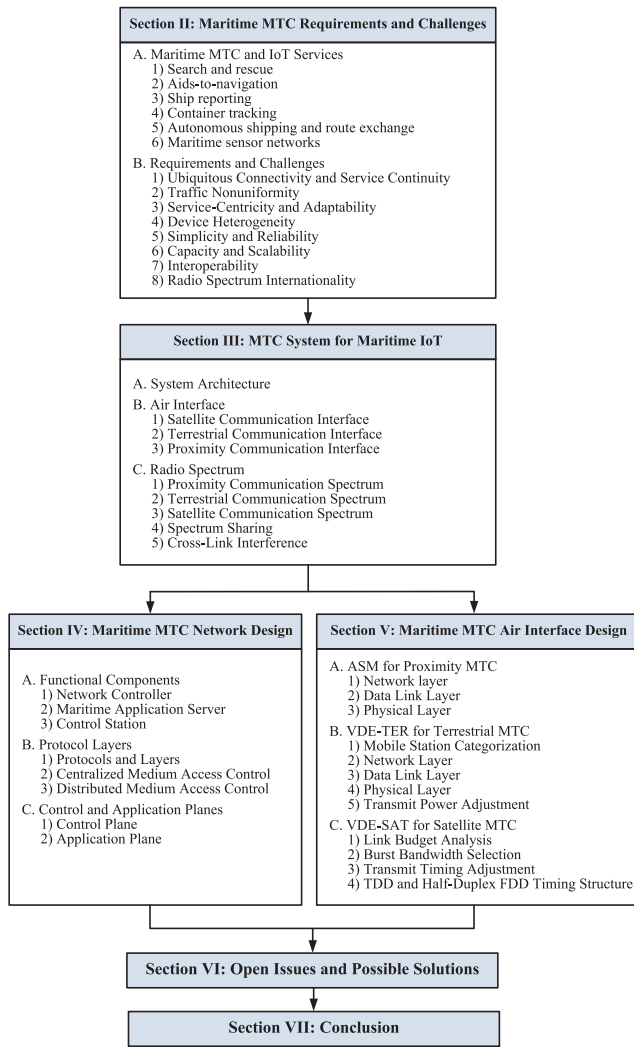

Fig. 1. Paper organization diagram.

with a maritime MTC system to meet the related maritime IoT requirements, including the maritime IoT architecture, the radio frequency spectrum allocation, as well as the radio interface. To materialize this concept, Sections IV and V are devoted to the design of a practical maritime MTC system, operating on the VHF spectrum licensed by ITU. Specifically, Section IV describes a service-centric network design, whereas the design of the radio interfaces, as well as the corresponding radio spectrum regulatory constraints, are delineated in Section V. Section VI discusses the open issues and possible solutions. Finally, Section VII concludes the paper by highlighting potential pitfalls to avoid in future development and standardization of the maritime MTC technology. We summarize the definitions of the acronyms that will be frequently used in this paper in Table I for convenience of reference.

II. MARITIME MTC REQUIREMENTS AND CHALLENGES

A. Maritime MTC and IoT Services

MTC is a form of data communication that involves one or more entities that do not necessarily need human interaction or intervention [2]. Maritime MTC is a type of MTC with

a specific application in maritime IoT within the broad field of MTC, in which most of the services require little or no human intervention and to work even in the absence of human operators and in harsh adverse marine environmental conditions.

Examples of such maritime IoT services include search and rescue (SAR), in which an MTC device installed on SAR equipment enables the communication between the equipment and maritime rescue coordination center or ships in the vicinity, providing precise location, weather condition, and other information that helps the SAR operation. MTC also allows the rescue coordination center to poll ships in the vicinity to ask for their SAR capabilities in an automated manner. Obviously, this type of device should require minimum human intervention to operate due to either lack of knowledge or physical incapacitation.

An aids-to-navigation device (e.g., a buoy or lighthouse) may use a maritime MTC device to provide precision piloting to passing ships in areas such as dangerous coastlines and channels, and hazardous shoals and reefs. Similarly, via the maritime MTC network, maritime safety information services provide vessels with navigational warnings, meteorological forecasts, and hydrographic services, among other safety-related information [19].

In ship reporting, a ship periodically broadcasts its static and voyage related information such as the ship's identification, draught, vessel type, its intended destination, and estimated time of arrival, or dynamic information such as position, speed over ground, course over ground, and navigational status. This information not only helps collision avoidance but also allows tracking and monitoring of vessels and maritime devices worldwide.

The purpose of a vessel traffic service is to provide active monitoring and navigational advice for vessels in a limited geographical area, particularly ports and waterways. The MTC network forms the basis for this type of service, through which transiting vessels report their identity, course, speed, and other data to the vessel traffic service provider and are, in turn, informed with navigational safety information, thereby decreasing vessel congestion, critical encounter situations, and the probability of a marine casualty resulting in environmental damage.

Container tracking allows for geo-locating a specific container onboard a cargo vessel, and even remotely monitoring the internal conditions. All parties involved in the shipping process can then reap the benefits that come with knowing the whereabouts and the conditions of the assets when making an oceanic voyage where there is no shortage of uncertainty. Real-time cargo tracking and tracing have become prevalent and vital for today's maritime service operators.

Autonomous shipping may be the ultimate way forward; route exchange, however, is the coveted and viable solution to vessel collision, in which ships in close proximity coordinate and optimize their routes autonomously via MTC so that close-quarter situations can be predicted and avoided at an early stage.

Smart navigation triggers the growing need for better "visibility" of operations at sea. Shipowners and fleet operators

TABLE I
LIST OF ABBREVIATIONS

5G	5th generation	NRC	network resource control module
AIS	automatic identification system	PAPR	peak to average power ratio
ARQ	automatic repeat request	PBBCH	physical bulletin board channel
ASM	application specific message	PDSCH	physical downlink signaling channel
BB	bulletin board	PDTCH	physical downlink traffic channel
BBCH	bulletin board channel	PDU	protocol data unit
CFI	carrier frequency index	PER	packet data error rate
CRC	cyclic redundancy check	PFD	power flux density
DSCH	downlink signaling channel	PRACH	physical random access channel
DTCH	downlink traffic channel	PTCH	physical traffic channel
ECC	electronic communications committee	PUSCH	physical uplink signaling channel
EIRP	effective isotropic radiated power	PUTCH	physical uplink traffic channel
FDD	frequency division duplexing	QAM	quadrature amplitude modulation
GEO	geostationary	RACH	random access channel
GMSK	Gaussian-filtered minimum shift keying	SCH	signaling channel
GPS	global positioning system	SDU	service data unit
HARQ	hybrid automatic repeat request	SNR	signal-to-noise ratio
IMO	International Maritime Organization	SINR	signal-to-noise and interference ratio
IoT	Internet of Things	TCH	traffic channel
IP	internet protocol	TDD	time division duplexing
ITU	International Telecommunications Union	TDMA	time division multiple access
LEO	low earth orbit	TTI	transmission time interval
MCS	modulation and coding scheme	UDP	user datagram protocol
MIR	maritime identity registry	USCH	uplink signaling channel
MMS	maritime messaging service	UTC	coordinated universal time
MMSI	maritime mobile service identify	UTCH	uplink traffic channel
MSR	maritime service registry	VDES	VHF data exchange system
MTC	machine-type communication	VHF	very high frequency
NM	nautical mile	WRC	world radiocommunication conference

may monitor fuel consumption and machinery performance to improve maintenance and vessel operations, prevent equipment failures and poor performance, and reduce downtime. With MTC, vast amounts of data coming from heterogeneous sources are made available for technologies, like artificial intelligence, big data, and blockchain, to harness and leverage the full potential of data, turning them into actionable intelligence for optimizing operational efficiency and hence reducing the ecological footprint.

Indeed, ocean activities and processes have direct environmental impacts and human implications. Yet the understanding of the ocean system is still far from complete, and ocean research infrastructure is much needed to support both fundamental research and societal priorities. Maritime MTC is expected to play an essential role in meteorological and oceanographic information collection via maritime sensor networks for monitoring, studying, and protecting the marine environment.

B. Requirements and Challenges

It is now evident that the fundamental goal of the maritime MTC is, simply put, the provision of connectivity to various types of maritime IoT applications and services. Along with this ultimate goal, there are a number of essential requirements

and critical challenges that have to be factored into the design of a practical maritime MTC system [3].

1) *Ubiquitous Connectivity and Service Continuity*: First and foremost, a maritime MTC system is required to provide ubiquitous connectivity between vessels (including maritime devices) and shore on a global scale, especially over open oceans, including the most remote areas of the world like the Polar Regions, to ensure unbroken and consistent existence of maritime services. Currently, the presence of services in offshore settings is limited by the crucial lack of adequate information and communication infrastructures. This situation poses a unique and serious challenge since, unlike in terrestrial communication where wide-area wireless coverage is provided via the mass deployment of base stations, it is obviously impractical (if not impossible) to cover the open oceans with deployments of such base stations.

Moreover, today's maritime service networks are still in a campus-style deployment. Depending on the national of the vessel, *cross-region* continuity of maritime service remains inconsistent and even absent. Service continuity between even neighboring countries is still in question. Indeed, ownership or governance remains to be the main stumbling block to a unified global maritime service network. Although the lack of trust and the undeniable appeals of maximum data authority and infrastructure control are driving the adoption of privately

managed connectivity across maritime service networks, ultimately, a unified cooperative service network is essential for global maritime IoT to provide the roaming ability with undisturbed services across organizational, regional and national boundaries especially in times of crisis [20].

2) *Traffic Nonuniformity*: Despite its global nature, marine traffic is highly unevenly distributed. Heavy traffic concentration is typical in ports, near-shore, and waterways. For instance, coastal shipping accounts for about 60 percent of the total maritime transport of goods to and from the main ports within the European Union [21], where the cargo ships primarily follow the routes that are set near the shore wherever possible while moving between trading ports. Quite the contrary, marine traffic on the high seas is mainly from intercontinental transportation or deep-sea shipping, and is relatively sparse in density. The maritime MTC network thus calls for an effective solution to cope with this type of traffic characteristics.

3) *Service-Centricity and Adaptability*: Unlike traditional mobile networks where applications and services are built around the network architecture, the maritime MTC network aims at supporting the efficient provisioning, discovery, and execution of various types of maritime application and service components distributed over the network or maritime cloud in order to reap the full benefits of moving to maritime IoT.

As aforementioned, maritime IoT applications and services vary from simple periodic reporting to route exchange and remote control (for, e.g., autonomous shipping). As such, a maritime MTC system is not confined to a one-time design and deployment. It is expected to offer amorphous services that adapt to a wide variety of maritime IoT specific needs and match changing demands. Hence both network configuration and communication resources must be made flexible and adaptive to the specific service offered. At the same time, the network needs to ensure that only the qualified or authenticated services are available to the vessels or maritime devices, and vice versa, for maritime safety and security. Evidently, the traditional maritime communication system that lacks the architecture and protocols for dealing with diverse maritime applications and interworking with other networks (e.g., the Internet where most service providers reside) is no longer up to the task or adequate for this requirement.

4) *Device Heterogeneity*: In order to serve diverse maritime IoT applications, maritime MTC is required to support various types of MTC devices from the low-end or low-cost category with reduced functionality to the high-end category with full functionality. A low-cost device is typically used for mass deployment like sensors and buoys that generate a small amount of data periodically and are mostly power or energy-limited, while the high-end device is for a large vessel like a ship that encompasses a premises network, i.e., a local area network with multiple maritime application hosts. A clear and present challenge that faces maritime MTC is the high degree of heterogeneity of the devices in terms of the communication capabilities, including hardware and power supplies.

5) *Simplicity and Reliability*: Simplicity has traditionally been the overall system design criterion for maritime

communication systems. It must be taken into consideration as we strive to meet these goals and requirements since a simpler system is faster to develop, cheaper to manufacture, easier to maintain, greater in longevity, and most importantly, more reliable and robust under complex marine environments which is of paramount importance to maritime equipment and systems. Indeed, maritime communication devices must endure harsh weather and environmental conditions, under which simplicity can bring performance benefits to any maritime system.

Low-cost is also an essential factor that cannot be overlooked. In order to modernize the maritime industry and improve the safety of navigation, the MTC system will eventually be mandated on all ships by the international maritime authority like IMO. Therefore, free-loyalty becomes essential to the selection/ development of the MTC technology.

6) *Capacity and Scalability*: It is foreseeable that the demand to handle the ever-growing maritime traffic will place high stress on the MTC system and drive the need for higher capacity. Efficiency is vital to maximize the system capacity constrained by the extremely scarce communication resources (i.e., the radio spectrum). Physical and higher layers of the MTC system are hence to be optimized to enable spectrally-efficient communications. In addition, the system must be *scalable* with future growth when resources are added in response to the growing demand for capacity and increasing bandwidth needs.

7) *Interoperability*: Interoperability is the ability of different maritime applications and services to exchange and integrate information flexibly, effectively, consistently, and cooperatively. These applications are provided by various organizations and businesses across the whole spectrum of the maritime industry. Interoperability is then at the very center of the maritime IoT's promises and is fundamental to its success. For that reason, maritime MTC is expected to offer the ability for different maritime IoT applications and services to access the network seamlessly both *within* and *across* network boundaries, and to provide portability of information efficiently and securely across the complete spectrum of maritime IoT services without effort from the end-user or host, regardless of its manufacturer or origin.

In fact, maritime service providers are already beginning to adopt Internet-based applications as a foundational component of their information technology (IT) platform. Therefore, for the maritime IoT to succeed, maritime MTC must migrate from the traditional maritime communication ideology to a newer, more efficient network and protocol concept to take on this new challenge.

8) *Radio Spectrum Internationality*: Another essential element for a maritime MTC system is the radio communication spectrum, which is undoubtedly the most critical component for any wireless communication system, and even more so for maritime MTC because of its *global* coverage nature. Nevertheless, the radio spectrum is a natural resource, and natural resources contained within a nation's geographic boundaries are generally owned by that nation. To successfully deploy the MTC system worldwide and to function properly, it is imperative that an international frequency band is available and established with appropriate international standards

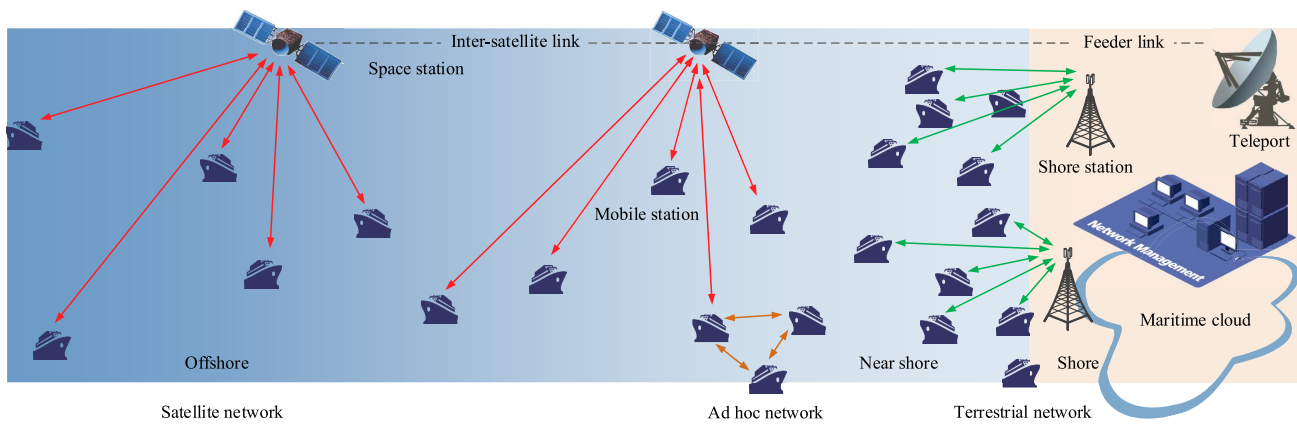

Fig. 2. Illustration of a space-earth integrated maritime IoT system that consists of satellite and terrestrial networks as well as ad hoc networks [2].

and regulations. To meet this goal, technical and regulatory challenges must be addressed by the international standards and regulatory bodies, as well as by the world's maritime community.

All these requirements play a significant role in determining the success of a maritime MTC system. The following sections provide the possible solutions intended to meet these unique requirements and challenges.

III. MTC SYSTEM FOR MARITIME IOT

A maritime MTC network is responsible for facilitating communication between vessels or maritime equipment and the maritime service providers for maritime IoT. The unique requirements of maritime IoT warrant not only a unique network and radio interface design but radio spectrum allocation as well. To materialize this concept, we need: 1) a maritime MTC system architecture, 2) radio/air interfaces that accommodate diverse maritime service and equipment requirements, and 3) internationally-authorized radio spectrum.

In this section, we take a high-level look at such a general system in respect of these three aspects.

A. System Architecture

Recalling from Section II, we know that the first and foremost requirement of maritime MTC is the provision of ubiquitous connectivity between vessels and service providers over open oceans worldwide to ensure maritime service continuity. This requirement poses a unique and serious challenge since unlike in terrestrial communication where wide-area wireless coverage is provided via the mass deployment of base stations, it is obviously unrealistic to cover the open oceans with such infrastructure. The solution is the deployment of a satellite MTC network to form a space-earth integrated maritime MTC system as graphically illustrated in Fig. 2.

Under this envisioned architecture, a *mobile station* is an MTC terminal aboard a vessel or embedded in maritime equipment. It provides wireless interworking between the maritime MTC network and maritime equipment or a premises network. Such a premises network can be a sensor network or a local area network aboard a ship with one or more end-hosts running diverse applications.

The maritime cloud is a trusted platform to provide various maritime services and applications with the highest computational and storage capacity in the maritime IoT framework. The federated network management combines the salient features of service provision, management, and orchestration with dynamic resource management/consolidation, service resolution, and forwarding mechanisms, through which the physical infrastructure resources are maximally shared among service providers, and are fine-tuned to meet the individual service requirements, thereby enabling service-centric networking.

The nearshore communication of mobile stations with the maritime cloud is through dense *shore control stations*, whereas offshore connectivity is provided by large-footprint satellite *space control stations*. The space station acts as a relay mainly for offshore communication via satellite ground station or teleport, thereby facilitating communication beyond the reach of the shore stations, especially over open oceans, as well as in the most remote areas of the world. The nearshore traffic is hyper-dense, whereas offshore is much sparser. Thus, the MTC system makes use of both “micro-coverage” to handle the hyper-dense nearshore traffic by network densification exploiting spatial spectrum reuse, and “macro-coverage” to accomplish the global coverage. Also, an ad hoc or self-organized network can be quickly established to facilitate direct communication among mobile stations in the vicinity for maritime proximity services.

B. Air Interface

Obviously, only wireless solutions are applicable to maritime communication. However, communication at sea differs significantly from its land counterpart; the unique maritime MTC requirements impose significant challenges to not only the maritime MTC network architecture but also the air interface. Notably, the abundance of maritime services and features for specific applications calls for flexible air interface configuration per the diverse service requirements. To this end, more than one type of air interface must be in place to effectively address the service requirements. From Fig. 2, at least three types of air interface can be identified for a full-fledged maritime MTC system.

1) *Satellite Communication Interface*: Considering the usually harsh and remote environment of the open seas and the overbearing costs of building terrestrial infrastructure at sea, it becomes clear that satellite communication is the sole alternative for deep-sea communication out of reach from any terrestrial solution. Unlike most terrestrial alternatives, a satellite communication system can be rolled out more quickly and economically more viable for connecting remote locations across a large geographic area due to the large footprint on the surface of the earth of a satellite transceiver, even after taking into account that launching a satellite network is composed of significant resource and time-consuming processes [22]–[25].

However, satellite communication suffers from some drawbacks, mainly: 1) inefficient to cover the high-dense traffic area due to the large footprint of a satellite and limited communication capacity; and 2) substantial propagation delay due to the high altitude of a satellite space station, which could be problematic for ships in close quarters in a dense traffic area. As such, in recent years, there has been increasing interest in low earth orbit (LEO). As it is near to the earth (e.g., 600 km), LEO satellites launched in LEO orbit has a smaller footprint (~1400 nautical miles or NM in radius) than that for geostationary (GEO) satellites. It has the least propagation delay (about 10 ms) compared to the other orbits. Continuous coverage is provided using multiple satellites configured in constellations with complex interlocking orbits [26]. The LEO space stations are interconnected via inter-satellite links and connected to ground stations through feeder links.

The communication range of a station is ultimately limited by the radio horizon, which is determined by the antenna height of the transceiver. Since a satellite space station has a much larger field of view than a mobile station on earth, mobile stations within the field of view of a satellite are likely beyond the radio horizon of each other. Because of this vast discrepancy in “visibility,” sensing-based distributed medium access control is ineffective in preventing collisions at the satellite receiver, whereas centralized medium access control via space stations is more efficient and provides higher system capacity.

2) *Terrestrial Communication Interface*: Despite the reduced footprint and latency, a LEO satellite network is still not adequate to serve the high traffic locations like ports, harbors, and waterways. Instead, network densification through deployment of shore station based infrastructure in these areas better exploits the spatial spectrum reuse owing to the much smaller footprint of a shore station. The satellite network is thus “hybridized” with a wireless terrestrial component to cover locations that are unsuitable to serve for the satellite network.

In the hybrid model, the terrestrial network handles communications with clustered vessels near shore as a complement to the satellite network. The high-dense traffic area is partitioned into multiple small areas covered by multiple shore stations, where these shore stations reuse a radio channel. The overall capacity is thus multiplied. Tight interference management, i.e., intra-cell and inter-cell co-channel interference, is critical in achieving high spectral efficiency and system capacity in such dense deployment. Hence, centralized medium access

control is employed by the shore station to reap the full benefit of the terrestrial network infrastructure.

3) *Proximity Communication Interface*: Communication between vessels or maritime devices is needed to support self-organized communication without the benefit of an existing infrastructure for proximity-based services, such as route exchange and aid to navigation. A proximity communication interface between neighboring mobile stations is needed for such a purpose. It operates through an autonomous or distributed resource allocation mechanism for self-organized networking, useful in the absence of satellite and terrestrial network coverage, and ideal for maritime proximity services.

These three types of air interfaces complement each other, and jointly, they provide a hybrid wireless access method for a truly space-earth integrated, service-centric MTC system for maritime IoT.

C. Radio Spectrum

If maritime MTC is the backbone of maritime IoT, radio frequency spectrum is, by all means, the heart and soul of maritime MTC, whose worldwide existence depends on the “internationality” of the radio spectrum.

Just like any other natural resource, the radio spectrum within the geographic boundaries of a nation is owned by that nation. However, the global coverage nature of maritime MTC requires the radio spectrum allocation on a global scale, rather than a campus-style, like its land counterparts. Therefore, the radio spectrum for maritime MTC must be allocated through an international regulatory agency, like ITU.

In this subsection, we examine such a spectrum that is recently allocated by ITU for *e*-Navigation under the previously presented MTC architecture within the VHF maritime mobile band (156 to 174 MHz) [27]. The realization of such an MTC concept on this particular radio spectrum is referred to as the VHF Data Exchange (VDE) System or VDES for short.

1) *Proximity Communication Spectrum*: As shown in Fig. 3, the VHF maritime mobile communication band is channelized into 25-kHz individual subbands or frequency channels, of which Channels 2027 and 2028 are dedicated to the maritime proximity communication, coined Application-Specific Messaging or ASM under VDES. Next to these two ASM channels, Channels 2087 and 2088, are the legacy AIS channels.

2) *Terrestrial Communication Spectrum*: Also, in the same maritime mobile band, paired frequency channels 24, 84, 25, and 85 are allocated to the terrestrial air interface, referred to as VDE-TER under VDES, all as *simplex* channels as shown in Fig. 3a [28]. A simplex channel allows for “one-way” transmission only, either uplink (from mobile stations to a control station) or downlink (from a control station to mobile stations), recalling that the terrestrial component of maritime MTC employs the infrastructure-based communication method under centralized medium access control. This traditional paired allocation facilitates frequency-division duplexing or FDD, which requires two simplex radio channels at each communicating end, one for transmit

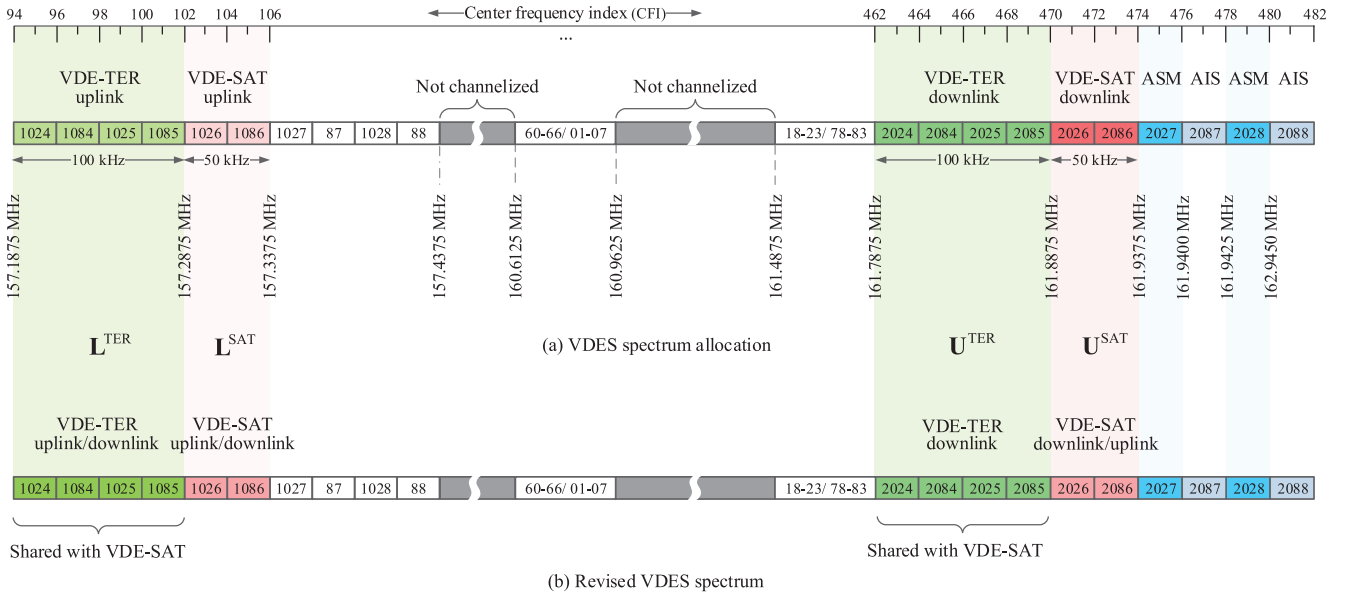

Fig. 3. Radio spectrum allocation for VDES [4], where the maritime mobile spectrum is channelized into 25-kHz individual frequency channels, and identified by *channel indices*; $L^{TER} \triangleq \{1024, 1084, 1025, 1085\}$, $L^{SAT} \triangleq \{1026, 1086\}$, $U^{TER} \triangleq \{2024, 2084, 2025, 2085\}$, $U^{SAT} \triangleq \{2026, 2086\}$, and $U^{ASM} \triangleq \{2027, 2028\}$. The center frequency index or CFI is an index to a frequency starting from 156 MHz in a raster of 12.5 kHz. For instance, a CFI value of 98 indicates a center frequency of $156.0125 \text{ MHz} + 98 \times 12.5 \text{ kHz} = 157.2375 \text{ MHz}$.

and one for receive with the remote end configured as the opposite [29].

Following the FDD spectrum allocation tradition, the lower leg, including channels 1024, 1084, 1025 and 1085, is assigned to uplink transmissions, denoted as

$$L^{TER} \triangleq \{1024, 1084, 1025, 1085\}, \quad (1)$$

and the upper leg, including channels 2024, 2084, 2025, and 2085, is assigned to downlink,

$$U^{TER} \triangleq \{2024, 2084, 2025, 2085\}. \quad (2)$$

3) *Satellite Communication Spectrum*: Spectrum allocation for the maritime MTC satellite component (i.e., VDE-SAT) is more complicated than that for VDE-TER, mainly due to the satellite *downlink* interference to the incumbent land systems on the same frequency band [4].

As depicted in Fig. 3a, paired frequency channels 26 and 86 are allocated for VDE-SAT, with the lower leg, channels 1026, and 1086, denoted as,

$$L^{SAT} \triangleq \{1026, 1086\}, \quad (3)$$

and the upper leg, channels 2026, and 2086,

$$U^{SAT} \triangleq \{2026, 2086\}. \quad (4)$$

Both are *simplex* channels, facilitating the traditional FDD transmissions, with L^{SAT} for the uplink and U^{SAT} the downlink.

As noted before, the radio spectrum as a natural resource is geographically owned by nations. Although the VDE-SAT downlink channel is on the international VHF maritime mobile band (156–174 MHz), *on land*, this same band in most countries is allocated to conventional and trunked land mobile systems by safety agencies, and utilities and transportation companies, e.g., police, fire, ambulance services, dispatched

services, radar systems, and railroad services [30]. Therefore, coordination between the VDE-SAT systems and the *victim* systems (i.e., the incumbent land systems in this frequency band) is a matter of the utmost importance.

The challenge lies in the fact that there is no existing regulatory rule directly established for the protection of the land system against the satellite system or the like, and hence the evaluation of the potential impact on the incumbent land systems becomes difficult if not impossible. A method adopted in the current analysis is to place general restrictions on the emissions from space stations inferred from the existing regulatory rules for interference protection between legacy land systems specified by ECC and ITU. The restrictions are expressed in terms of values of the maximum allowed electromagnetic *power flux density* (PFD) emitted by any space stations to the surface of the earth at all possible incident angles in a reference bandwidth (e.g., 25 kHz). In a nutshell, it serves as a “protection mask” for the land system such that the *actual* interference that the victim land system experiences is no worse than that from a *land* mobile system permitted by these *existing* regulations. This concept is graphically illustrated in Fig. 4, henceforth referred to as the *PFD mask*, denoted as $\Psi(\theta)$, where $\theta \in [0^\circ, 90^\circ]$ is the elevation angle of the land station. $\Psi(\theta)$ is derived from the original land system regulatory restrictions and used as the constraint on the emission energy from the space stations for protection against the harmful interference to the incumbent co-frequency land communication systems. The derivation of $\Psi(\theta)$ is provided in great detail in [2]. To conform to this PFD mask, the effective isotropic radiated power (EIRP) of the satellite space station with a Yagi antenna must satisfy the $\Lambda^{\text{satellite}}(\phi)$ as shown in Fig. 4, where $\phi = \arcsin(R(R+h)^{-1} \cos(\theta)) \in [0^\circ, 66^\circ]$ is the nadir offset angle of the space station (R the radius of the earth, and h the orbital altitude of the space station).

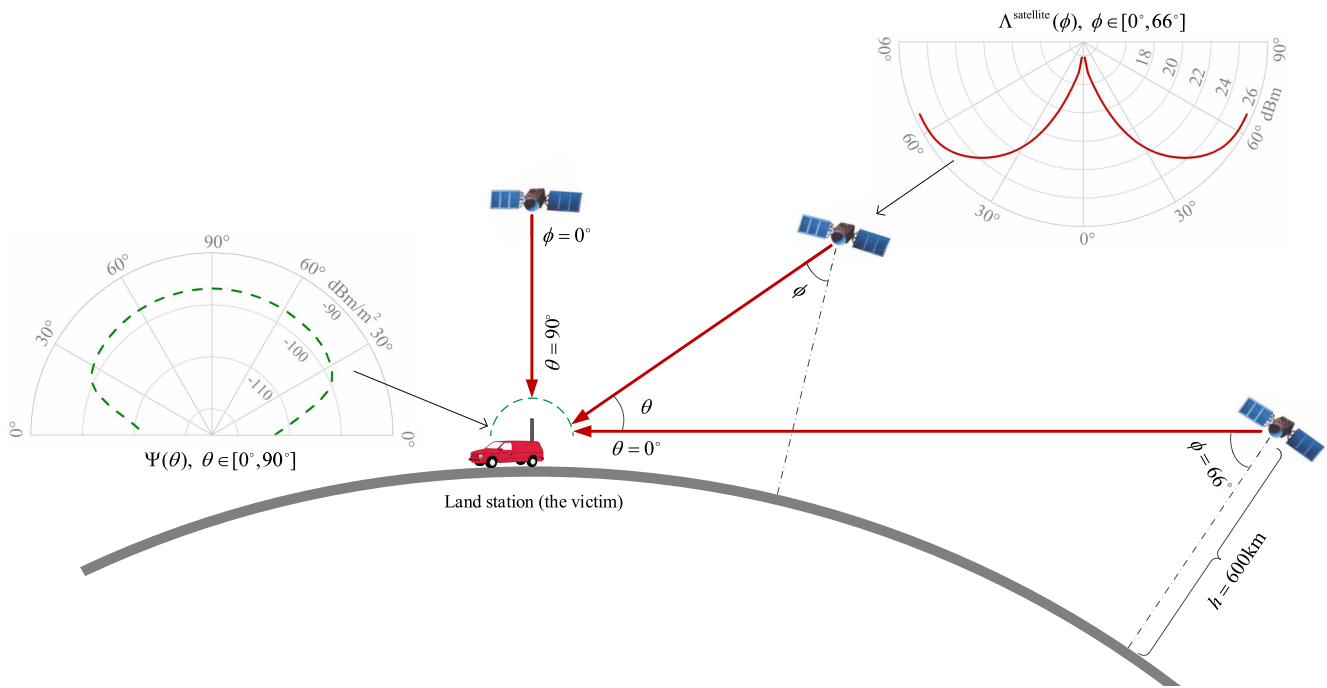

Fig. 4. Illustration of the concept of a “PFD mask” for protection of the *land* stations: the interference into a co-frequency land station receiver from a space station (the aggressor) at the elevation angle from $\theta = 0^\circ$ to 90° , corresponding to the nadir offset angle from $\phi = 66^\circ$ to 0° , where the EIRP (per 25 kHz) of a typical antenna (Yagi antenna) of the space station is constrained by the PFD mask (per 25 kHz).

4) *Spectrum Sharing*: As aforementioned, VDE-TER is mainly for limited coastal areas; its spectrum, $\{\mathbf{L}^{\text{TER}}, \mathbf{U}^{\text{TER}}\}$, is thus mostly *underutilized*, leading to an inefficient and wasteful use of extremely scarce VHF spectrum resources. Therefore, in principle, the allocation allows VDE-SAT to utilize the VDE-TER spectrum provided that the transmission does not cause harmful interference to VDE-TER. However, in practice, it is non-trivial for real-time coordination of a satellite space station with the shore stations in its field of view along its traveling path over various countries or regions.

Recall that the PFD mask, $\Psi(\theta)$, ensures that the interference from the VDE-SAT downlink can be absorbed by the land systems. Consequently, the same should also hold for VDE-TER. Under this concept, a VDE-SAT space station is free to transmit on the VDE-TER spectrum anytime and anywhere, as long as the EIRP constraint is satisfied, thereby negating the need for such real-time coordination with VDE-TER systems on earth. As illustrated in Fig. 5, a space station is thus free to use both VDE-SAT and VDE-TER spectrum, i.e., \mathbf{U}^{SAT} and \mathbf{U}^{TER} , *anywhere* for downlink transmissions under the constrained EIRP, $\Lambda^{\text{satellite}}(\phi)$.

For VDE-SAT uplink, the mobile station opportunistically uses the VDE-TER spectrum \mathbf{L}^{TER} for VDE-SAT uplink transmissions wherever the absence of the VDE-TER service can be assured. A design presented in [4] facilitates such assurance. As illustrated in Fig. 6, the presence of a VDE-TER system is indicated by a “beacon signal” transmitted by a shore station. Only outside the beacon coverage is \mathbf{L}^{TER} available for VDE-SAT uplink transmissions. The range of the beacon is extended beyond the VDE-TER cell coverage to create a “buffer zone” that protects the VDE-TER uplink, especially for those of mobile stations at the edge of the coverage. The

buffer zone should be sufficiently large such that VDE-SAT transmissions on \mathbf{L}^{TER} seen by the shore station are below the noise level. For that, the VDE-SAT downlink transmission should avoid overlapping with the beacon signals to assure that the beacon is protected for maximum detectability. An ideal candidate for such a beacon signal is the downlink system broadcast signal, i.e., the System Bulletin Board broadcast signal, PBBCH, as described in Section V-B.

A mobile station thus refrains itself from transmitting VDE-SAT signals on \mathbf{L}^{TER} whenever a beacon signal can be detected; instead, the dedicated VDE-SAT channels, \mathbf{L}^{SAT} , is preferred for VDE-SAT uplink transmissions if satellite communication is needed within the no-share zone. The buffer zone diminishes as the VDE-TER coverage becomes limited by the radio horizon, and the no-share zone coincides with the VDE-TER coverage, in which case, the reception of the transmission from the edge mobile station by the shore station is naturally protected by the horizon.

5) *Cross-Link Interference*: An important issue with the traditional FDD communication is the protection of the receiver from the co-located transmitter at each communicating end. The *out-of-band* emissions will enter into the receiver band, and affect the whole receive path, degrading its sensitivity. For the prevention of the out-of-band emissions of a transmitter from leaking into the co-located receiver, a *full-duplex* FDD transceiver relies on the RF filter coupled with *spatial* separation between the transmit and receive RF chains. Since spatial separation is costly or physically challenging to achieve, most FDD systems mainly depend on *frequency* separation between the two paired frequency channels to ease the transceiver design, to the extent that the same antenna can be used for both transmit and receive with the help of an

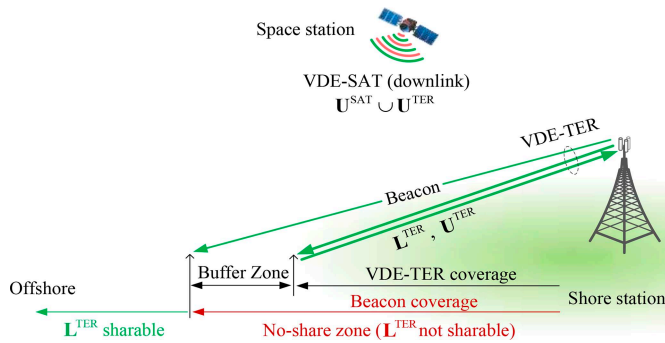

Fig. 5. VDE-TER spectrum sharing scheme with VDE-SAT: U^{TER} is sharable with VDE-SAT downlink anywhere; L^{TER} cannot be shared within the no-share zone.

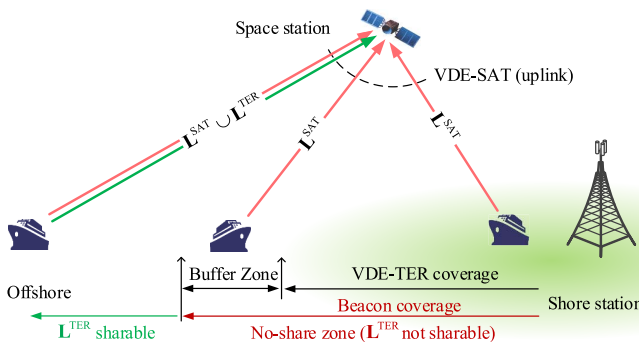

Fig. 6. Outside the “no-share zone” a mobile station is free to use both VDE-SAT spectrum and VDE-TER spectrum, $\{L^{\text{SAT}}, L^{\text{TER}}\}$, for *uplink* transmissions; whereas within the no-share zone, the VDE-TER spectrum is restricted from mobile stations for VDE-SAT communications.

RF duplexer. This frequency separation is especially crucial for systems operating in the lower end of the radio spectrum, including the VHF maritime mobile band.

Let us refer back to Fig. 3a. The 4.6-MHz frequency separation between the uplink (L^{SAT}) and downlink (U^{SAT}) could be problematic for VDE-SAT space stations. From Fig. 4, the space station transmit power can be up to 26 dBm/25 kHz, minus the antenna gain of 8 dBi, i.e., 18 dBm/25 kHz. More than 76 dB of isolation at a 4.6 MHz separation is thus needed in order to bring the out-of-band emissions (e.g., phase noises) from the output of the transmitter down to below noise floor by, e.g., 6 dB, assuming the noise temperature is 26 dBK. This degree of isolation requires a transceiver to provide stringent RF isolation via high-performance VHF filter systems and/or *spatial* separation of transmit and receive antennas, which could be practically difficult for both payload-limited (e.g., 20 kg) and dimension-limited (e.g., $20 \times 30 \times 40$ cm) LEO space stations, especially in the 160-MHz frequency band. So, likely only *half-duplex* FDD can be supported for VDE-SAT, which negates the need for a transceiver to transmit and receive simultaneously.

A viable solution to circumvent this cross-link self-interference without sacrificing the spectral efficiency is to employ the TDD transmission technique. With the *time* separation provided by TDD, the transceiver of a station never needs to transmit and receive at the same time, but still maintains full channel utilization (almost), which maximizes the

spectral efficiency and hence system capacity. This concern was initially raised in [2], and was brought to the attention of ITU. The simplex allocation plan in Fig. 3a has since been revised. Both lower and upper legs of VDE-SAT, L^{SAT} and U^{SAT} , are now classified as *duplex* channels, as depicted in Fig. 3b, allowing both uplink and downlink transmissions in these channels for *optional* TDD transmissions [27].

The particular advantage of TDD is the great simplification of out-of-band interference isolation. Another advantage is the extra degree of freedom for the network to allocate communication resources in proportion to the traffic demand in both directions by varying the time partition of the uplink and downlink transmissions to better address the “service-centricity” requirement for heterogeneous maritime IoT applications and services. Nonetheless, the downside is that TDD complicates the interference management, which requires the synchronization of uplink and downlink between stations as well as between VDE-SAT and VDE-TER [4]. Another caveat is that two sets of RF frontend filters/amplifiers may be needed for the paired (FDD) bands, which is not natural for TDD.

IV. MARITIME MTC NETWORK DESIGN

In this section, we provide a general design of the maritime MTC system from the network perspective to meet the diverse service requirements outlined in Section II.

A. Functional Components

First of all, instead of adopting a traditional network-centric architecture, a service-centric network is desirable. To this end, the design provides three types of network entities: *Network Controller*, *Maritime Application Server*, and *Control Station*, as depicted in Fig. 7.

1) *Network Controller*: The maritime MTC Network Controller is a *logically* centralized entity in charge of the infrastructure control and management from a global perspective to provide network-related control functionalities essential for MTC. In particular, it aims to exploit the flexible and agile integration of the terrestrial and satellite domains to provide the network capabilities for mobile stations to access a wide variety of maritime applications and services. It brings network function virtualization and service chaining into both domains to establish an end-to-end virtualized network. It enables “software-defined networking” based maritime resources management, thereby enabling automated provisioning of network applications that may have diverse characteristics and ensuring that specific applications are getting the proper network resources or characteristics. The Network Controller properly configures all the resources and infrastructure components necessary for a specific maritime application or service. It executes the resource control function via a Network Resource Control module (NRC) responsible for configuration, provisioning, optimization, remediation, lower layer control of the stations, and terrestrial and satellite system integration, among many other things.

2) *Maritime Application Server*: The Maritime Application Server is also a *logically* centralized entity that automates

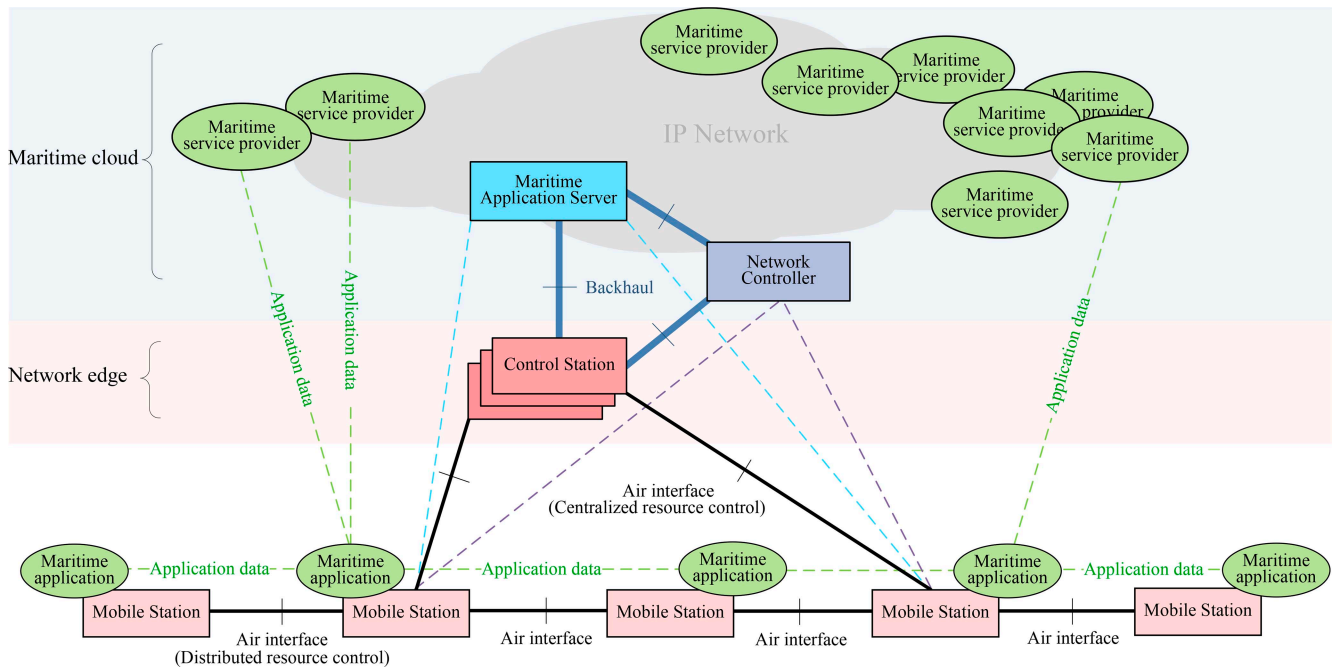

Fig. 7. VDES network functional view and topology for service-centric maritime MTC networking [3], where solid lines denote physical interfaces, and dashed lines logical connections.

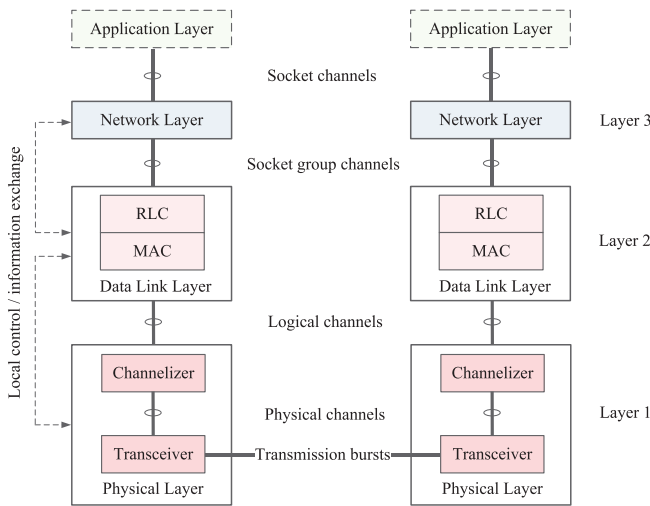

Fig. 8. The maritime MTC protocol stack consists of three native layers: the Network Layer, the Data Link Layer, and the Physical Layer. The Application Layer is not an intrinsic part of the stack. Here, the channelizer is a functional entity that converts logical channels into physical channels, and vice versa.

the end-to-end provisioning (the setup and management) of the maritime services and applications. It maintains a federated repository of provisioned maritime services, i.e., Maritime Service Registry (MSR), providing a runtime registry for service discovery, which contains the current information as to where to reach a running maritime service. In particular, MSR is responsible for 1) identification and authentication of maritime applications and services, virtualization and abstraction of these applications and services in the form of the *service profile*, including network locations and settings, pre-shared keys, traffic patterns, quality of service, and other service characteristics, 2) presentation of the service profiles

to the Network Controller to enforce corresponding traffic management policies, 3) populating and updating of service instances across the network, and 4) convergence and adaptation between internal (maritime MTC) and external (IP) networks to provide resource and power-efficient and seamless interoperability with the service providers.

3) *Control Station*: A Control Station resides at the “edge” of the network, which can be either a *shore station* or a *space station*. In addition to serving as a wireless access point to the MTC network for mobile stations, it also maintains an “edge deployment” of a part of the centralized functionalities, which decides the best way to perform the functions and enforce them within the group of individually managed mobile stations. It communicates with its central counterpart to perform functionalities that require up-to-date centralized information and management, thereby maintaining a logically centralized but physically distributed vision of the network. This approach provides the centralization of these functions with distributed control, allowing automation of the entire network without limiting scalability through the centralized control points.

B. Protocol Layers

A large-scale communication network, like the maritime MTC, requires a well-designed protocol structure for interoperability and flexibility.

1) *Protocols and Layers*: A protocol is a set of predefined rules and formats that govern the way or process of communication between communicating peers. A single unit of data for information exchange between peer protocols is commonly referred to as the *Protocol Data Unit* or PDU. The content and format of the PDU, as well as how the PDU is exchanged, are defined by the protocol. The implementation

of the maritime MTC system involves many processes or protocols to complete the delivery of a message. Some of these protocols are not dependent on other protocols, but some are. Such dependencies between processes can be represented by a layered structure or layering. With a layered structure, a protocol belongs to one of the layers, and depends on the service provided by the layers below it. A layer, except the lowest layer, i.e., Layer 1, depends on the lower layers to get its PDU across to its peer. A data unit for containing or encapsulating the PDU passed down from the immediate upper layer is commonly known as the *Service Data Unit* or SDU. The independent protocols thus reside in the lowest layer, responsible for providing services to the upper layers. The maritime MTC protocol structure adopts the four-layer model, consisting of three native layers, as shown in Fig. 8.

Layer 1 or the *physical layer* handles the transmission and reception of data through the protocol's defined physical channels, i.e., the radio interfaces. Layer 2 or the *data link layer* enables data exchange between stations within the MTC network; its functions typically include data segmentation and multiplexing, medium access and transmission error control, as well as cyphering in some cases.

At the data link layer, a station (control or mobile) is uniquely identified or addressed by a 9-digit Maritime Mobile Service Identity (MMSI). MMSI was initially issued by ITU in 1982 to uniquely identify ship stations and shore stations, or a group of stations [31].

Layer 3 is the *network layer* whose primary function is to maintain the interconnection of application hosts. For proximity communication, it is between the hosts on mobile stations, and for terrestrial and satellite communications, it is between the hosts on mobile stations and the hosts on the maritime cloud. Therefore, the destination is typically not the "station of interest," but, more often than not, "service of interest." In general, the network layer includes protocols for resource management, Layer-3 address resolution, and inter-network adaptation between the maritime MTC network and the IP network if the connection involves two different networks.

On top is the application layer, which, however, is not native to the maritime MTC system.

Information flowing between these layers is through the concept of "channels." These channels are used to segregate different types of protocol data or PDU, and provide interfaces to layers within the protocol stack, allowing them (PDUs) to be transported between layers.

As depicted in Fig. 9, the network layer receives application data through channels coined "sockets." Depending on the service profile (provided by the Application Server), the data are then grouped and passed on to the data link layer through "socket groups," each of which is associated with a specific service profile, represented by, e.g., some predefined *priority* index.

Besides the traffic generated by applications, the network layer itself also creates traffic between various peer protocols such as NRC and MSR. Socket groups thus define what type of data is to be transferred. The data link layer makes use of this information to manage the transmission of various types of *application traffic* and *network control traffic*

TABLE II
PDU HEADER SUMMARY

Network layer Traffic PDU header			
Type	ServiceID	ClientID	
00	16 bits	6 bits	
RLC PDU header			
Segmentation status		Sequence index	
2 bits		6 bits	
MAC Signaling PDU header (optional)			
Type	Control function		
1	7 bits		
MAC Traffic PDU header			
Type	RLC instance	SDU size (byte)	Reserved
0	7 bits	10 bits	6 bits

and strives to meet the corresponding service requirement for the given radio resources. For the control traffic generated by the various functions of the network layer described in the previous section, Socket Group 0 is the default logical channel. Table II (top) defines the header of the network layer application Traffic PDU. A two-bit type field can define up to four types of application Traffic PDUs.

The data link layer consists of a radio link control (RLC) sublayer and a medium access control (MAC) sublayer. There is an RLC instance associated with each socket group. When necessary, the network layer PDU is segmented into multiple segments in the form of RLC SDUs, as shown in Fig. 9. As such, PDUs from the same RLC instance are numbered sequentially with a *sequence index* included in the RLC PDU header listed in Table II. The RLC PDU is assigned a *segmentation status* that is used to indicate the position of the segment in the original RLC SDU after segmentation. With the RLC PDU header, the RLC peer on the receiver side can reassemble these RLC SDUs to recover the original network layer PDU once all the fragments are received.

These RLC PDUs are then individually packed into MAC PDUs, henceforth referred to as the MAC Traffic PDUs. Each MAC Traffic PDU is tagged with an RLC instance and SDU size as its header for demultiplexing at the receiver. Depending on their priorities and the payload of the data link PDU, multiple MAC Traffic PDUs and MAC Signaling PDUs are multiplexed into a data link PDU, which is passed on to the physical layer for transmission. The payload of the data link PDU is determined by the medium access control function of the MAC sublayer that performs resource allocation and modulation and coding scheme (MCS) selection in order to meet the service requirement associated with the RLC instance. This information is communicated to the receiving peer through a MAC Signaling PDU. Depending on the service requirement, transmission error control, i.e., Automatic Repeat Request or ARQ, may also be needed, which is the job of the MAC error control function. Note that the MAC Signaling PDU header may be omitted wherever there is no ambiguity, for signaling efficiency.

As such, different types of logical channels are utilized by the data link layer to carry out such tasks. The Traffic

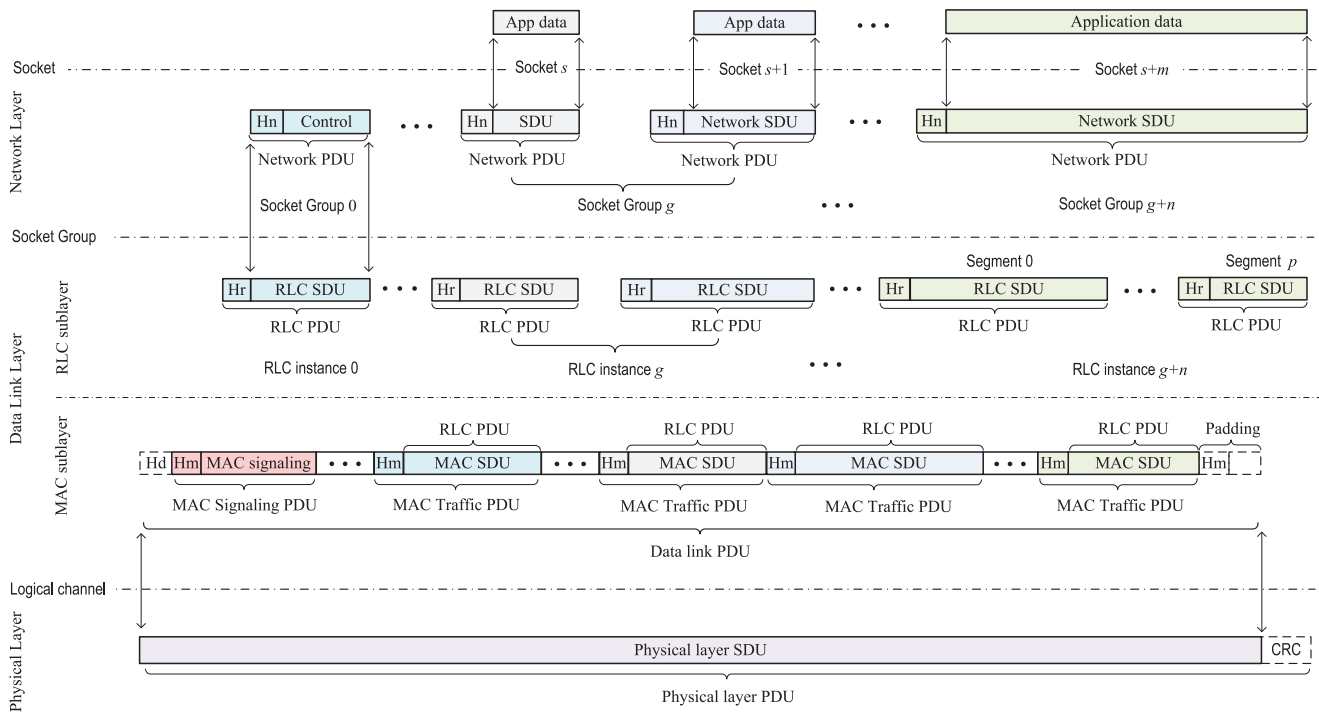

Fig. 9. Illustration of protocol layer interfaces, where H_n stands for the network layer header, H_r the RLC header, H_m the MAC header, and H_d (optional) the datalink header. CRC (optional) denotes cyclic redundancy code. As shown, MAC Signaling PDUs can occupy one physical layer PDU or can be piggybacked with Traffic PDUs.

Channel (TCH) is mainly used for transporting the network layer PDU; the Signaling Channel (SCH) is for delivering MAC Signaling PDUs from a receiver to the transmitter regarding the state of a TCH, e.g., ARQ signaling. The Assignment Channel (ACH) serves the purpose of medium access control, including resource allocation as well as modulation and coding scheme for the physical channel that carries TCH.

A physical channel is a set of specific radio resources for *physically* carrying one or more specific logical channels over the air in the form of *transmission burst* typically associated with a specific radio waveform depending on the modulation and coding scheme.

2) *Centralized Medium Access Control*: For air interface with centralized medium access control, i.e., VDE-TER and VDE-SAT, there is a notion of uplink and downlink. As shown in Fig. 10, on the uplink, the Physical Uplink Traffic Channel (PUTCH) is mainly for carrying the uplink TCH (UTCH), and the Physical Uplink Signaling Channel (PUSCH) is dedicated to the uplink SCH (USCH). On the downlink, the Physical Downlink Traffic Channel (PDTCH) is for carrying the downlink TCH (DTCH), and the Physical Downlink Signaling Channel (PDSCH) carries downlink SCH (DSCH) together with ACH for better efficiency. Pertinent to the centralized MAC mechanism, the ACH is only for the MAC sublayer of a control station to announce the resource assignments to both PUTCHs and PDTCHs.

The Paging Channel (PCH) is for the data link layer (MAC) to page specific mobile stations with pending downlink data. PCH is typically transmitted at a low duty cycle

so that the mobile station can enjoy a long period of sleep to save energy. It is thus designed for mobile stations with prioritization of energy efficiency over latency, suitable for services less sensitive to delay. Obviously, for latency-sensitive services, a mobile station should monitor the ACH at all times for incoming data at the expense of energy efficiency.

Also pertinent to the centralized MAC is the Random Access Channel (RACH) that is used by a mobile station for sending short messages to the control station on a Physical Random Access Channel (PRACH) selected from a pool of *shared* PRACHs among mobile stations in a contention-based fashion, negating the need for resource scheduling. A Common Control Channel (CCCH) is for broadcasting the resource configuration of physical signaling channels (e.g., PUSCH and PRACH), from the control station to all mobile stations.

The Bulletin Board Channel (BBCH) is for a control station to broadcast the system configuration parameters from NRC (see Section V) on the dedicated Physical Bulletin Board Channel (PBBCH).

3) *Distributed Medium Access Control*: For air interface with distributed medium access control for proximity communication, e.g., ASM, the Physical Traffic Channel (PTCH) is used to carry TCH as well as SCH. The Physical Signaling Channel (PSCH) is for carrying ACH, as depicted in Fig. 11.

C. Control and Application Planes

The execution of the functionalities of the Network Controller and Maritime Application Server is through two separate virtual planes, known as the control plane and

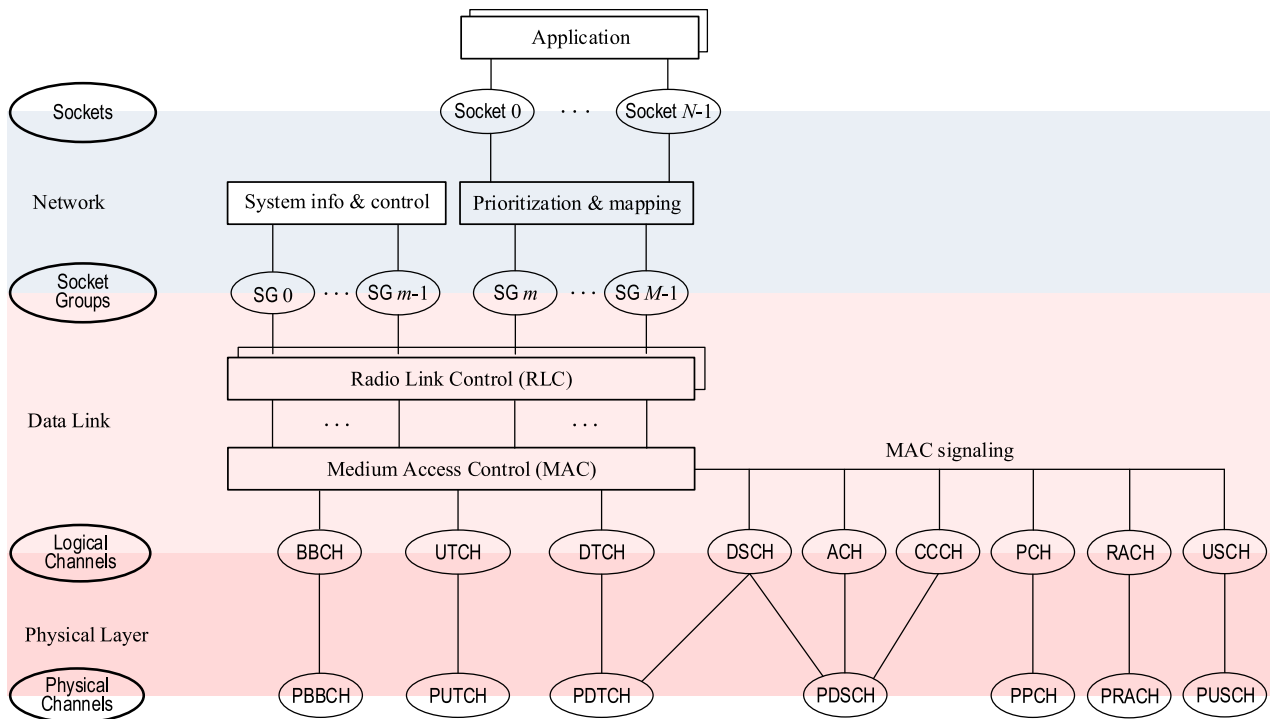

Fig. 10. Layer channels and mapping for air interface with centralized medium access control, e.g., VDE-TER and VDE-SAT.

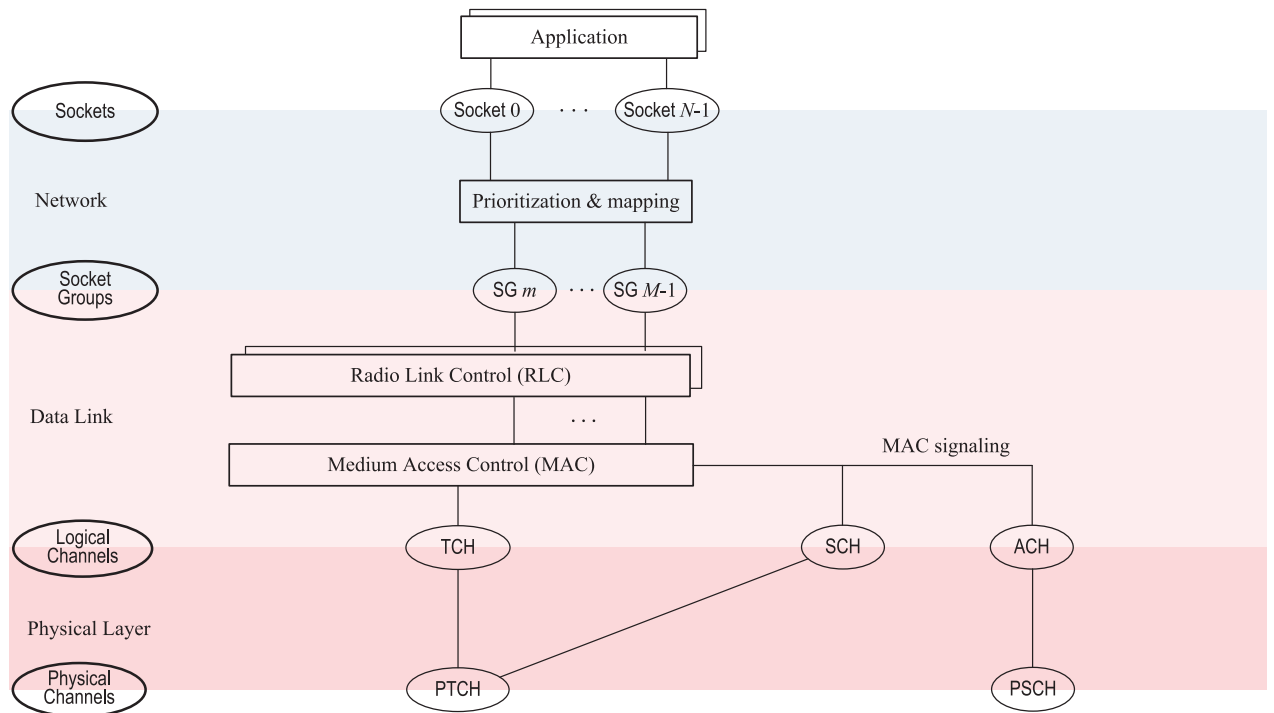

Fig. 11. Layer channels and mapping for air interface with autonomous/distributed medium access control, e.g., ASM.

the application plane, through a distributed architecture that includes the maritime MTC infrastructure edge nodes, i.e., the control stations, as depicted in Fig. 12. This architecture supports monitoring network statistics that provide visibility not only to the overall network topology but also into specific application performance, which is then used to calculate and establish communication paths over the terrestrial or satellite

domain, and push down rules to the edge nodes on a per user per service basis, guiding the network behavior at the desired application traffic granularity. Therefore, application traffic can be engineered flexibly, pursuing one or a combination of goals such as maximizing aggregate network utilization, providing optimized load balancing, lowering latency, minimizing power consumption, and other generic traffic optimization techniques.

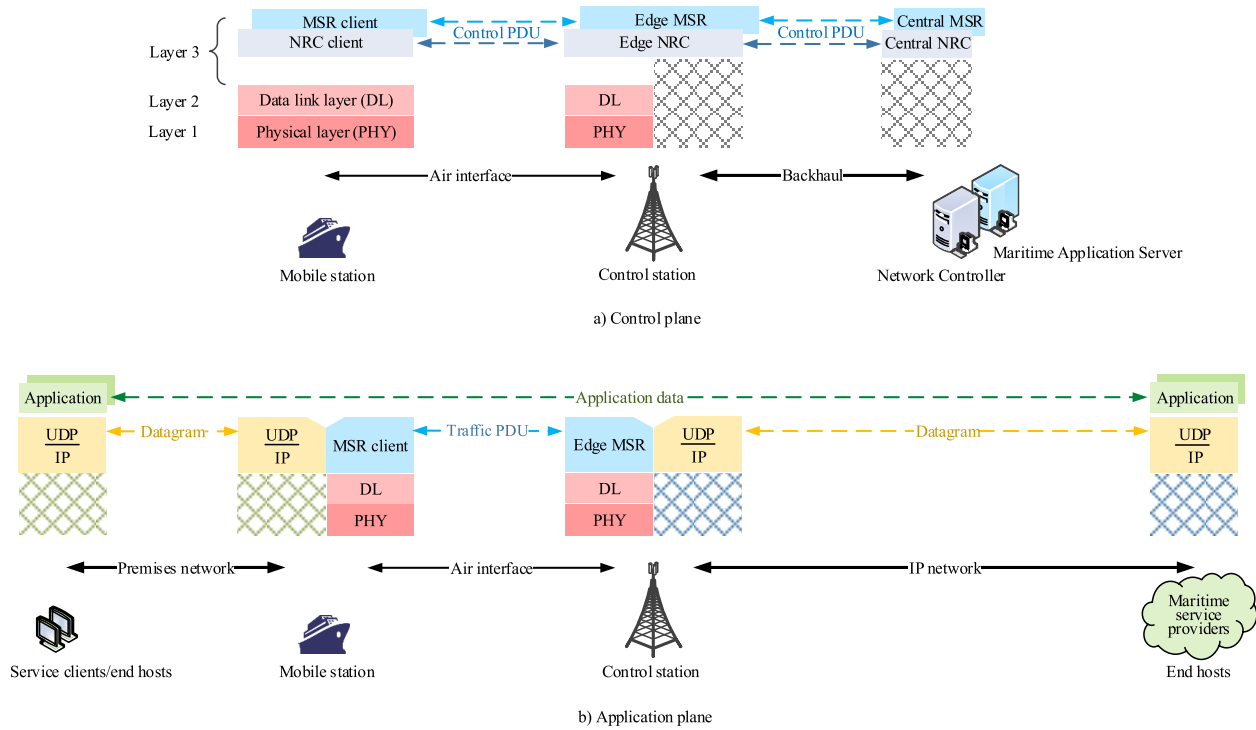

Fig. 12. VDES protocol stack and interfaces/reference points: (a) the control plane, and (b) the application plane, where “Control PDU” stands for the network layer Control PDU that carries the network layer control traffic, and “Traffic PDU” stands for the network layer Traffic PDU (cf. TABLE II) that carries the application traffic. The shaded blocks denote the native layer services of the practical implementation.

1) *Control Plane:* The Network Controller and Maritime Application Server naturally resides in the network layer. They abstract a common set of virtualized control plane functions or modules and executes these functions on the control plane, as depicted in Fig. 12a.

As noted a little earlier, the NRC of the Network Controller configures all the resources and infrastructure components necessary for a specific maritime application or service, including configuration, provisioning, interference coordination, among many other things, through network layer Control PDUs.

All stations participating in the communication exchange control information to make the real data exchange possible. In this regard, the control plane provides the necessary means and attributes for stations informing the Controller about its capabilities; the Controller configures the station, and the station provides status and performance information. In other words, the ultimate goal of communication is to transfer the application and service data between communicating stations. But to make this happen, there are many things (especially a lot of lower layer issues) that need to be configured. Typically, these configurations change dynamically at the time of communication. NRC is thus responsible for the selection, configuration, and control of the radio links for communication between stations. It defines a common and generic information model for the operation and control of radio link network elements, intended to facilitate the integration of distinct air interfaces and frequency spectrum solutions under a common and single control framework.

The Network Controller may also contain a *Maritime Identity Registry* (MIR) responsible for the identification and

authentication of mobile stations, a federated authority for identities of persons, organizations, or ships that are using the network. Authentication is a process by which the network verifies the identity of a station that wishes to access the network. Since access control is usually based on the identity of the mobile station, which requests access to a resource, authentication is essential to security.

Furthermore, the location of a mobile station may constantly change, and the situation at sea where the vessel is encountered is continuously changing, which necessitates maritime services that support safe and efficient operation worldwide. Therefore, another essential function of the Network Controller is the mobility management that tracks the location of mobile stations worldwide that enables the maritime service to use the location information of the mobile station. As such, the Network Controller maintains a *Maritime Messaging Service* (MMS) that supports store-and-forward functionality for reliable delivery and geo-casting of messages, through which messages can be exchanged between a mobile station and a maritime service provider or mobile stations in a target area using unicast or broadcast, and maps geographic location-related information to appropriate target areas for the broadcast.

Nevertheless, in the current design, MIR and MMS are not deemed as intrinsic components of the network layer; instead, they are treated as the network services provided by applications.

Also, as previously noted, the Maritime Application Server maintains a centralized repository of provisioned maritime services, i.e., MSR. The provision and maintenance of the

maritime application and service information, including the service identifier and service profile, are from the central MSR, via the network layer Control PDUs to the edge MSR and the MSR client over the control plane, as shown in Fig. 12a. The relevance of MSR to maritime MTC will become evident next.

The definitions of the network layer Control PDUs are beyond the scope of this paper.

2) *Application Plane*: While the MTC channel for a specific maritime service is established and supervised over the control plane, the application plane that is logically separated from the control plane is for execution and accomplishment of the service under the supervision of the Maritime Application Server (see Fig. 12b).

The message generated by the application and received by the network layer of a mobile station is processed, and set for delivery through the IP suite (e.g., UDP/IP) for IP-based maritime services. The problem with the IP is that it is itself rather costly in that a 128-bit source and destination address included in an IPv6 packet means that a minimum size of a packet is 256 bits before any other IP header. This overhead is a significant burden, especially for most maritime application messages of short bursty nature, and for a narrowband system like VDES with limited bandwidths (see Section III-C).

Also, there is a choice for the transport protocol, TCP and UDP. TCP provides reliable, ordered, and error-checked delivery between applications via an IP network. The function of TCP is to control the transfer of data so that it is reliable through connection management, reliability control. Connection management includes connection initialization (a 3-way handshake) and its termination. TCP opens the connection and complete all the handshaking formalities before transferring the message to another node. Hence, even short messages need a minimum of 7 packets, thereby introducing extra delay and overhead.

Reliability is achieved by the sender TCP detecting lost segments and retransmitting them. A retransmission of the TCP segments occurs after a packet is lost indicated by a timeout, when the acknowledgment (ACK) is not received by the sender. TCP is reliable in the sense that the protocol itself checks to see if everything that was transmitted is delivered at the receiving end. ARQ is performed to ensure that all data transmitted is received.

UDP, on the other hand, provides a connectionless datagram service that emphasizes reduced latency over reliability. UDP does not require creating a connection; a message is transferred without handshaking, which is ideal for short burst data services. It is not reliable in the sense that it does not ensure the delivery of the data to the destination. It requires less header overhead than TCP. UDP is therefore ideal for short burst data services (typical for maritime IoT) and preferred as the transport protocol; if specific reliability is needed for certain applications, it is preferred to be implemented within the application or via the service profile as part of QoS to be accomplished by the data link layer more efficiently.

High spectral and energy efficiency is crucial for the maritime MTC system. To improve the over-the-air communication efficiency, the Maritime Application Server serves as a “gateway” that sits between two networks, i.e., the internal

maritime MTC network and the external IP network, where the maritime service providers reside. Without a valid public IP address, a mobile station’s message inside the maritime MTC network cannot be routed to the external maritime service providers on the public IP networks, and vice versa. Hence, the Maritime Application Server resides in the network layer, encompassing functions that abstract the maritime services and adapt standard protocols to hide the topology and complexity of the IP packet data network from the maritime MTC network, and vice versa. This adaptation provides a means for mobile stations to interact with the service providers without being overburdened by the resource and power-hungry wired protocols that drive the IP network, which is a significant simplification for the mobile station and radio resource-saving for the network.

To that end, the Maritime Service Registry or MSR of the Application Server maintains a list of the authenticated maritime services, each of which is identified by a Maritime Service Identifier, or *Service ID* (e.g., 16 bits) – a Layer-3 identifier. This information is provisioned to the control and mobile stations over the control plane, as part of the control traffic. Fig. 13 demonstrates how service data (application traffic) is exchanged between the end hosts over a premises network, the MTC network, and the IP network.

For outbound application traffic (i.e., the service data from a service client on the maritime MTC network to the service provider on the public IP network), the MSR client at the mobile station receives the datagram via the socket from the service client destined to the service provider addressed by the server’s public IP address and port number (destination IP and port). The MSR extracts the payload (service data) from the datagram, and places it in a network layer Traffic PDU, replacing the destination IP address with the corresponding *Service ID*, and the service client’s private IP and port (source IP and port) with the *Client ID* (e.g., 6 bits). It then hands the PDU down to the lower layers for transmission over the air interface. Once received by the control station, the *Service ID* is converted back to the public IP address of the service provider (as the destination IP and port), and the *Client ID* together with the mobile station’s MMSI is mapped to a port number associated with the control station’s public IP address (as the source IP and port). A new datagram is then constructed, and routed to the destination over the public IP network.

For inbound application traffic, i.e., when the service provider responds to the service client, the control station takes the incoming datagram destined to it that carries the service data from a service provider, maps the destination port of the datagram back to the *Client ID* and the MMSI of the mobile station, and dispatches the service data (together with the *Client ID*) to the station (addressed by MMSI) over the maritime MTC network. Once received, the MSR client at the mobile station looks up the private IP address of the service client or the end host by the *Client ID*, and forwards the service data to the client over the premises network.

It is seen that, inside the maritime MTC network, the service client on the mobile station’s premises local network (Ethernet, for instance) is simply represented by a *Client ID*, whereas

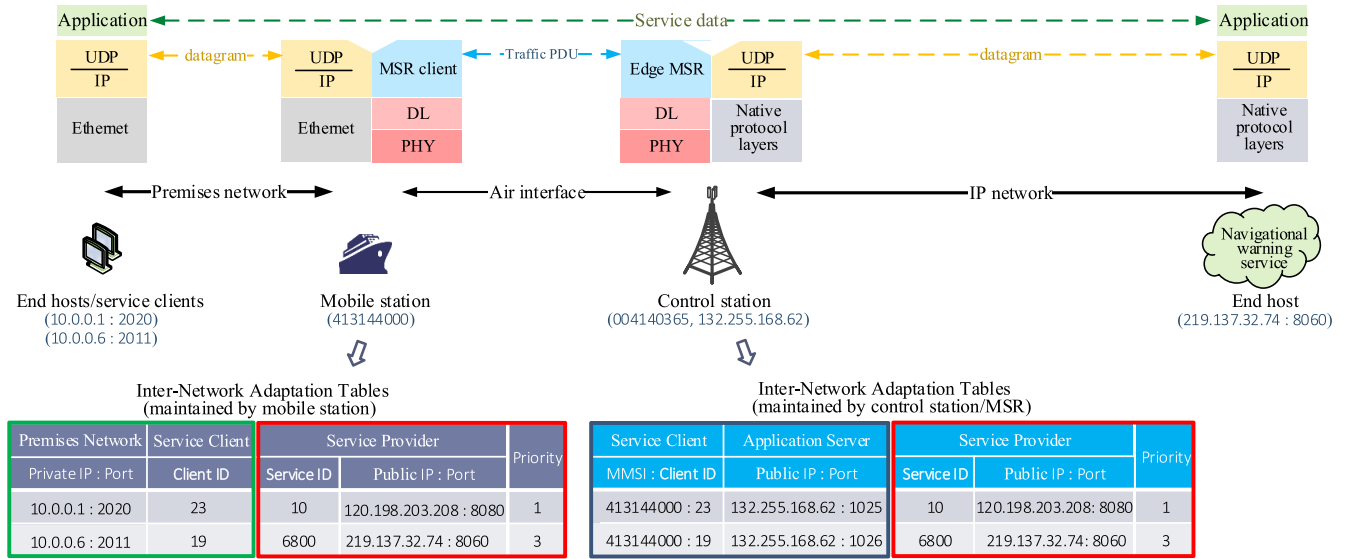

Fig. 13. Illustration of the interactions between the service clients reside on a premises network (e.g., Ethernet) and the service provider host on the public IP network via the maritime MTC network. In this example, a navigational warning service client (Client19) aboard a ship receives the service from the service provider at 219.137.32.74. The network layer Traffic PDU header format is defined in Table II.

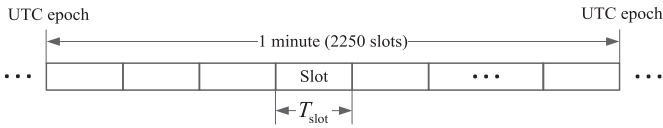

Fig. 14. Transmission slots and timing, where $T_{\text{slot}} = 80/3$ ms.

the service provider or the host at the other end is represented by a *ServiceID* maintained by the Maritime Application Server.

It is thus apparent that during the message exchange between a mobile station (in the maritime MTC network) and a service provider (in the IP network), the over-the-air overhead incurred by the IP network is kept to a minimum. This not only helps improve the system spectral efficiency but also helps reduce the energy consumption for those energy-limited maritime devices. More importantly, this ensures that only the qualified or authenticated services are “visible” to the mobile station, and vice versa.

V. MARITIME MTC AIR INTERFACE DESIGN

In this section, we go through a concrete design example of the maritime MTC air interfaces (mainly, Layers 2 and 1), based on the internationally allocated maritime MTC spectrum described in Section III-C, to see how the spectrum constraints and the service requirements outlined in Sections II influence the design.

The transmission structure of the air interfaces is organized into time *slots* such that one minute contains exactly 2250 slots, as illustrated in Fig. 14. These 1-minute worth of slots are aligned with the Coordinated Universal Time (UTC) minute boundary for ease of global time slot synchronization among stations. This slotted transmission structure is inherited from the legacy AIS for unification. A transmission burst lasts one or more than one slot. The number of slots that a burst

occupies is henceforth referred to as the *transmission time interval* (TTI).

The legacy AIS is an ad hoc communication air interface [32]–[37]. One of the shortcomings and limitations of AIS is the lack of a well-defined layered protocol structure. It imposes a strong tie between the application and the air interface, fundamentally limiting its applicability to broad maritime applications. As a result, only 64 *predefined* messages are supported, which are literally carved into the air interface, thereby preventing it from adapting to emerging diverse maritime IoT applications. This structure also strips away the freedom of the data link layer to manage the physical layer payload efficiently. Moreover, the air interface does not provide any channel coding, let alone any adaptive MCS necessary for efficient communication over wireless channels, thereby making AIS inherently unreliable, and power and spectrally inefficient.

A. ASM for Proximity MTC

To avoid the same pitfalls of the legacy AIS, the ASM air interface is intended for delivering more versatile maritime proximity applications and services, enabled by the protocol layer structure presented in Section IV, and empowered by the higher spectral efficiency and robustness physical channels through adaptive MCS.

1) *Network Layer*: As mentioned in Section III-B, maritime proximity communication is a particular type of MTC in that the target or destination of the communication is in the proximity. In this sense, it belongs to ad hoc networking for direct communication between neighboring mobile stations, bypassing a control station.

The Maritime Service Registry or MSR of the network layer is responsible for socket channel creation and maintenance, as well as mapping the socket channel to the socket group per service profile maintained by the MSR. Recalling from

Section IV-B, a socket is a logical construct that identifies a specific service or application, represented by a maritime service identifier or *Service ID* – a Layer-3 identifier maintained by the MSR, whereas a socket group defines what type or QoS of the application data is transported. The network layer thus decouples the air interface from the application by transporting application data to the data link layer through socket groups in the form of the network layer Traffic PDU.

Table II defines the network layer Traffic PDU header that contains a *Service ID* and a *Client ID*. For each socket channel configured at the transmitting station, there needs to be a peer socket at each receiving station that is signed up for the service. Now a receiving station uses this list of socket channels as a filter to screen out the irrelevant incoming messages, i.e., messages do not match the *specifications* of the listed socket channels.

As a client entity of the NRC, defined in the network structure in Section IV-C, the NRC client of the mobile station is in charge of the radio resource management involved in proximity communication over ASM, e.g., the radio channels available for ASM. From Section III-C, the default radio channels are Channels 2027 and 2028. The network layer thus stays in touch with the Maritime Application Server and the Network Controller for maritime service and radio resource provisioning and updates, via a backhaul, e.g., VDE-TER and VDE-SAT or other wide-area communication means.

2) *Data Link Layer*: With a socket group that defines what type of data is being transferred, the data link layer uses logical channels to define how the data is transported to its peer through the physical channel. For that, the data link layer depends on a set of protocols. In this section, we place the focus on the most relevant MAC sublayer functions and PDUs.

Distributed Medium Access Control: As noted in Section III-B, the self-organized or ad hoc communication topology is favorable to proximity communication. Transmission resources, i.e., the orthogonal time slots of a radio channel, are shared among stations in a time-division multiple access (TDMA) fashion. Slot selection is thus the core component of the TDMA-based MAC protocol. At the heart of the protocol is the distributed medium access mechanism in a *contention*-based fashion that allows mobile stations to share the same radio channel and operate *autonomously*, without the benefit of an infrastructure. The ASM MAC sublayer of a mobile station is responsible for the transmission slot selection.

Random TDMA is the simplest slot selection method. Each transmitter, sharing the slot time medium, randomly selects one or more slots and transmits a burst on the slot(s). All stations share a common time reference (UTC), ensuring transmissions are aligned with the TDMA slot boundary. When the burst collides with other bursts at the intended receiver, the receiver may not be able to recover the message depending on the signal strength relative to the interferers. Re-transmissions may be needed depending on the nature of the application and service. The collision probability is low when the radio channel loading is light. As the traffic density increases, so does the collision probability, and ergo the latency.

TABLE III
ASM MAC SO-TDMA PDU FORMAT

Header (Hm)		SDU		
Type	Controlfunction	slot timeout	Offset	Reserved
1	0000001	4 bits	7 bits	5 bits

Carrier-sensing TDMA uses the “listen before talk” mechanism to reduce the collision probability in random TDMA. Simply put, a mobile station verifies the absence of other traffic before transmitting on the shared TDMA slots of a radio channel. When a slot is randomly selected, instead of transmitting right away, the detection of channel activity is conducted at the start of the slot. If detected, the current slot is assumed to be in use, and the transmission is deferred. Otherwise, the slot is deemed to be idle, and the transmission is made on the remainder of the slot.

These two methods are particularly suited for data services that possess a bursty traffic pattern. For periodic data services, like ship position reporting, the sensing-based method is modified to produce improved performance by taking into consideration the periodicity characteristic of the service to reduce the collision probability.

Self-organized TDMA or SO-TDMA is a variant of virtual channel sensing, in which a mobile station uses information embedded in the previously detected transmissions to predict future traffic in the channel. In a nutshell, each transmission includes an indication of the TDMA slot that will be used by the transmitting station for subsequent transmissions. This knowledge allows stations to build up a ‘chart’ of which slots are in use. Each station avoids slots known to be in use by other stations for its own transmissions, thereby preventing two stations in the range of one another using the same slot.

This information sharing between MAC peers is through a MAC Signaling PDU, the SO-TDMA PDU. It contains a set of parameters to infer a particular resource reservation pattern associated with this transmission burst sequence, such as a counter indicating the number of reservations left in the current selection period. As shown in Table III, the SO-TDMA PDU follows the MAC Signaling PDU format. It contains a 4-bit *slot timeout* field that indicates the number of transmissions remaining until a new slot selection process (i.e., the slot re-selection process) is carried out: 0 means that this was the last transmission; 1-15 means that 1 to 15 minutes respectively are left until re-selection.

When a transmission is detected with the *slot timeout* counter value equal to zero, the sensing station that is in re-selection may lose track of the next “move” (transmission) of the transmitting station. Therefore, additional information is introduced into the transmission burst to indicate the offset (in slots) between the newly selected resource for future transmissions (as a result of the re-selection just described) and the current resource. The *offset* field thus indicates the re-selected slot position offset, by the *offset* value, from the previously selected slot at the re-selection at timeout 0.

After taking into consideration all reservation intentions from the detected traffic, the slots that are free of confliction

TABLE IV
ASM MAC ARQ PDU

Field	Bit width	Value
Type	1	1 (MAC Signaling PDU)
Function	7	2 (MAC ARQ)
DestinationMMSI	30	0-999,999,999
DestinationMMSI	30	0-999,999,999
DestinationMMSI	30	0-999,999,999
DestinationMMSI	30	0-999,999,999

TABLE V
ASM DATA LINK PDU HEADER (HD)

SourceMMSI	DestinationMMSI	Reserved
30 bits	30 bits	4 bits

with the reserved resources indicated by the detected traffic become the candidates from which the final slot(s) is *randomly* picked.

The SO-TDMA PDU is transported through SCH.

Automatic Repeat Request (ARQ): The MAC ARQ PDU is defined in Table IV, which contains feedback information for up to four data link PDUs from four different mobile stations.

MAC Traffic PDU: Multiple MAC PDUs can be concatenated into one data link PDU, as shown in Fig. 9. The data link PDU header contains both transmitter MMSI and the receiver MMSI, as defined in Table V.

The MAC PDU header devotes a `type` field to distinguish a Traffic PDU from a Signaling PDU as enumerated in Table II and Table III. The MAC PDU header also contains a `size` field for an indication of the MAC SDU size. Finally, the MAC PDUs are queued and multiplexed into the data link PDU, based on their priorities or Socket Group Indices.

Burst Configuration: In order to allow flexible physical layer configurations to facilitate adaptive channel modulation and coding schemes, the physical channel and the transmission burst configurations are indicated through a MAC Signaling PDU, i.e., the Burst Configuration PDU, which contains the information necessary for the receiver to decode the data link PDU that contains the MAC Traffic PDUs as well as the MAC Signaling PDUs (such as the MAC SO-TDMA PDU), transported through TCH and SCH, respectively, as shown in Fig. 15.

In particular, an adaptive modulation and coding scheme is employed as one of the MAC functions, which enables the ASM to adapt the MCS to the channel condition, as well as the QoS requirement of the RLC PDU, remembering that the data link layer utilizes the RLC instances to handle the socket groups. A benign radio channel plus a low-priority RLC PDU instance favors an aggressive or weak MCS, i.e., a high modulation order and a high code rate, to achieve a high spectral efficiency. In contrast, a poor channel condition or high-priority RLC PDU does the opposite, i.e., a conservative or strong MCS, at the expense of the spectral efficiency.

For signaling efficiency, the configuration of the physical channel and transmission burst is through a combination of physical layer PDU size and burst TTI, and is indicated by an identifier, referred to as `Link ID`. Table VI lists

TABLE VI
ASM LINK ID EXAMPLES

LinkID (6 bits)	PDU size	Burst TTI	Modulation	Code rate
...
2	21 bytes	1 slot	$\pi/4$ -QPSK	1/2
...
9	65 bytes	1 slot	16-QAM	3/4
...
35	223 bytes	3 slots	16-QAM	3/4
...

a few examples of the predefined configurations. Based on the physical layer PDU size and burst length, and the way that the PSCH and PTCH are constructed, as will be discussed shortly, the associated MCS can be derived through a predefined lookup table. For instance, `Link 2` corresponds to $\pi/4$ QPSK-modulation with an effective code rate close to 1/2; `Link 9` is 16-QAM with an effective code rate of about 3/4.

A 6-bit `Link ID` accommodates up to 64 predefined burst configurations and is conveyed via the 6-bit MAC Burst Configuration PDU, transported via the dedicated ACH.

3) *Physical Layer*: Although the GMSK waveform (used in AIS) has a power spectrum with excellent frequency localization, it lacks a simple way for extension to more spectrally-efficient higher-order modulations, and therefore, precludes incorporation of an adaptive MCS from enhancing spectral efficiency. Quadrature modulation ($\pi/4$ -QPSK and QAM) is thus employed. For notational simplification, we henceforth denote $\pi/4$ -QPSK as QPSK without differentiation.

An ASM transmission burst carries a PSCH, followed by a PTCH, as depicted in Fig. 15. The burst is transmitted at the same channel symbol rate as AIS, i.e., 9,600 symbols per second, but using square-root raised cosine waveforms with a roll-off factor of 1 to ensure minimal interference to AIS.

The physical layer PDU that carries the MAC Burst Configuration PDU via ACH is encoded into a 32-bit bi-orthogonal code and then modulated onto 32 BPSK-modulation symbols to form the PSCH, which takes up 32 symbols. It is coded independently from the PTCH to provide the receiver with the information required to decode the PTCH.

The integrity of the physical layer SDU associated with TCH or SCH is protected by a reliable 24-bit CRC, constituting a physical layer PDU. Following the information given in the Burst Configuration MAC PDU, the PTCH is constructed by turbo-encoding the corresponding physical layer PDU at a base code rate of 1/3. The systematic bits are stored in a circular buffer; the two streams of parity bits are first individually interleaved and then interlaced into the buffer. According to the payload (i.e., the total available channel symbols) of the physical channel, the modulation type can be determined, and then the total number of coded bits for transmission is determined. The same amount of bits are read out sequentially from the buffer. If the end of the buffer is reached, simply wrap around to the beginning until the required number of bits is

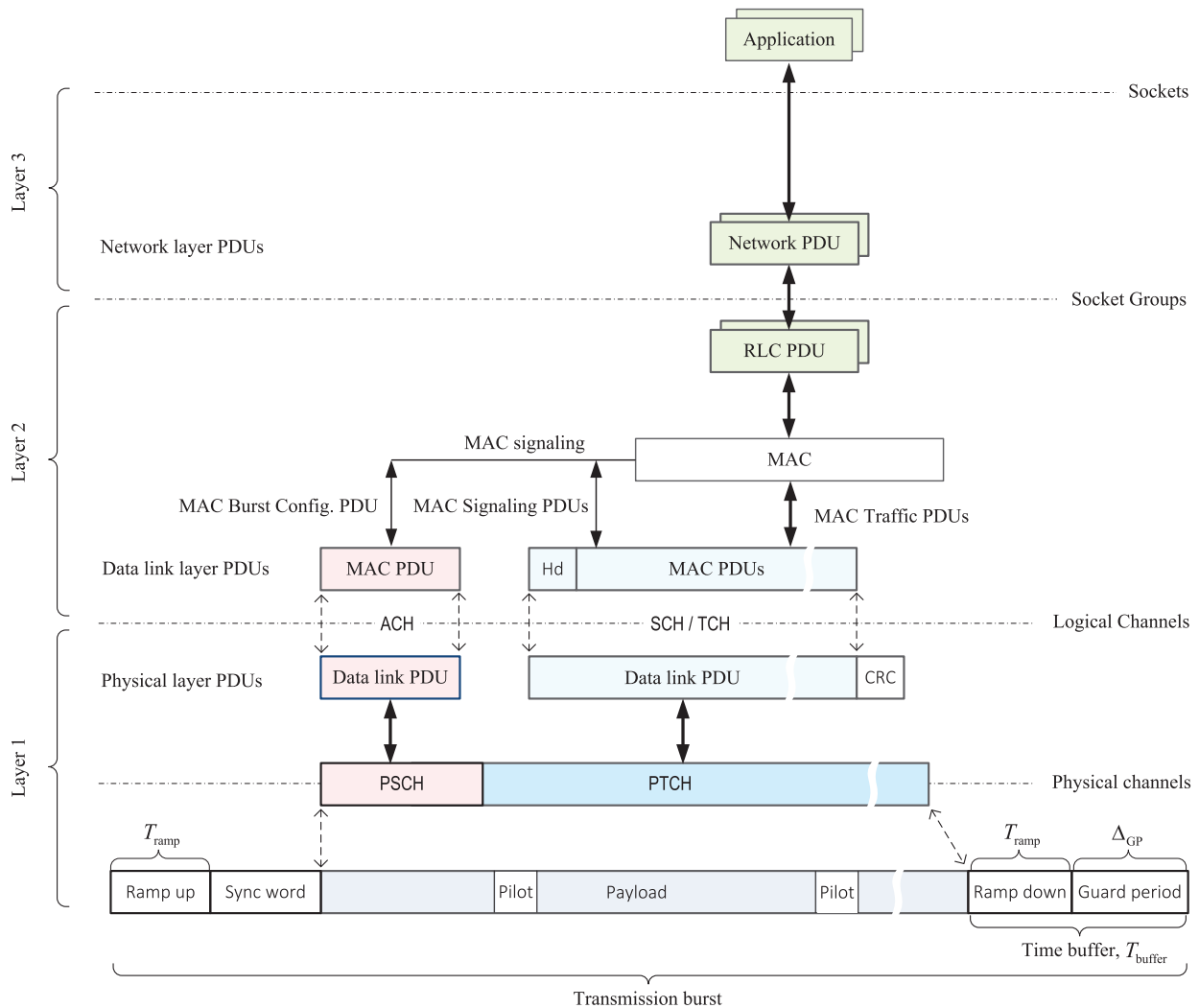

Fig. 15. ASM burst formation. The transformation from a physical layer SDU to PSCH or PTCH is described in the flow chart in Fig. 16. A burst occupies one or multiple time slots, where $T_{ramp} = 0.416$ ms (4 symbols).

acquired. This process is henceforth referred to as *rate matching*. After rate matching, these bits are channel-interleaved and quadrature-modulated. The resultant modulation symbols are then used to *fill up* the PTCH.

A transmission burst is structured to aid the transmission and reception of the physical channels (i.e., the PSCH and PTCH). The *sync word* is a particular waveform to assist a receiver to time-and-frequency synchronize to the incoming burst, as well as to estimate the channel for coherent demodulation of the following PSCH and PTCH. For that, the *sync word* waveform is required to possess a good autocorrelation function for best detectability and timing accuracy. In the current design, the waveform is based on the most commonly used pseudorandom (PN) sequence. The *sync word* occupies 31 channel symbols, initialized with QPSK symbols from a 31×2 all-zero bit sequence. It is later scrambled symbol-by-symbol with a special PN sequence during the scrambling process described in Section V-B.

Frequency errors cause the received signal phase, or equivalently, the radio channel phase to ramp, thereby jeopardizing the coherent demodulation of the modulation symbols. This

error includes the potential Doppler frequency shift that cannot be eliminated or reduced by a more accurate frequency source, e.g., GPS. It can only be estimated and compensated *on the fly* using reference signals or *pilot* signals, where a pilot is a predefined QPSK-modulation symbol (known to receivers). Pilots are thus inserted into the burst to help a receiver track the radio channel variability and reduce synchronization errors during the entire burst (see Fig. 15). A sequence of pilots, with 16 symbols apart between two adjacent pilots, is suitable for a frequency offset up to 300 Hz.

Finally, a smooth power ramp-up preamble and ramp-down postamble, each with a length of $T_{ramp} = 0.416$ ms (four symbols), are added simply to provide smooth power-on and off transitions of a burst to shape the spectrum of the burst, i.e., to suppress the out-of-band emissions aroused by the transitions. At the receiver, they, in effect, provide a *time buffer* up to T_{ramp} for collisions protection between bursts caused by propagation delays as well as timing errors. Another benefit of the ramp-up preamble is that it helps the automatic gain control (AGC) of a receiver converge.

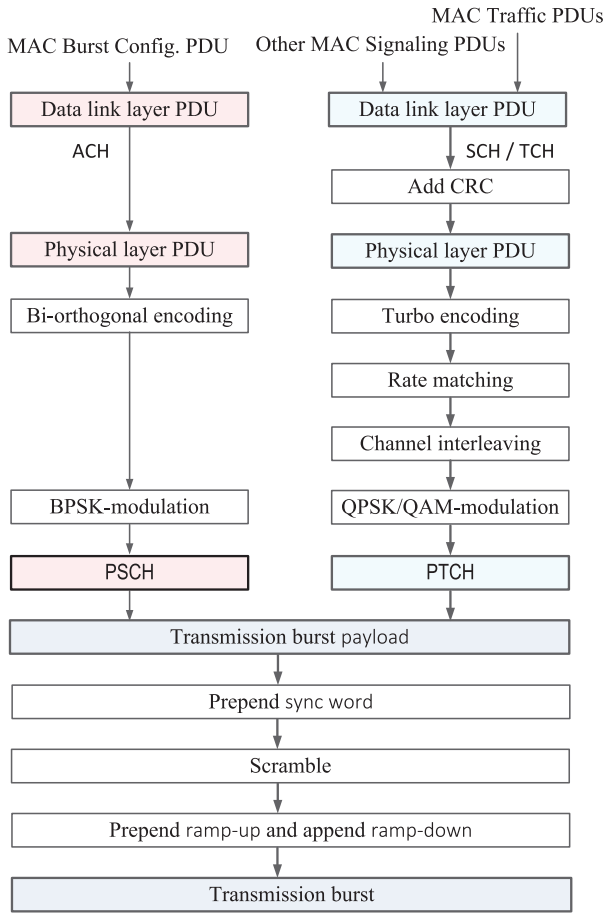

Fig. 16. ASM transmission burst generation flow chart.

The propagation delay is determined by the communication range, and the communication range at sea is ultimately limited by the horizon, which in turn is determined by the antenna height. A transceiver antenna that measures 100 meters tall covers up to a 40-NM communication range, corresponding to a $\delta_{\text{MAX}} = 0.25$ ms one-way delay. The UTC timing error can be assumed to be less than 200 μs , i.e., $|\varepsilon_{\text{mobile}}| < 200 \mu\text{s}$. We thus require a time buffer of length

$$T_{\text{buffer}} > \delta_{\text{MAX}} + 2|\varepsilon_{\text{mobile}}|, \quad (5)$$

i.e., $T_{\text{buffer}} = 0.65$ ms. Exploiting the ramp-up and ramp-down periods, a guard period,

$$\begin{aligned} \Delta_{\text{GP}} &= T_{\text{buffer}} - T_{\text{ramp}} \\ &\approx 0.24 \text{ ms} \end{aligned} \quad (6)$$

or three symbols (0.312 ms), is needed and reserved at the end of the burst.

In practice, a mobile station may synchronize directly to UTC via, e.g., the 1-pulse-per-second signal from a GPS receiver, whereas in the absence of UTC, the mobile station may acquire the slot timing through VDE-SAT or VDE-TER. The acquisition procedure is deferred to Section V-C.

B. VDE-TER for Terrestrial MTC

ASM operates under an autonomous or distributed resource allocation mechanism. The advantage is the great flexibility

that enables direct communication without the benefit of an infrastructure, i.e., control stations. Nevertheless, the disadvantage is also the lack of supervision of control stations that gives rise to frequent message collisions among transmitting stations in the high traffic area, such as ports, harbors, and waterways. Collisions cause not only poor overall system efficiency that limits the system capacity, but also instability. The terrestrial MTC component of VDES, i.e., VDE-TER, is thus created to alleviate this problem using a centralized resource management mechanism with the help of the control stations, i.e., the shore stations. More importantly, the VDE-TER infrastructure provides connectivity to the maritime cloud (see Fig. 7), allowing information exchange between a mobile station and the maritime service providers.

Under centralized medium access control, all communications are through the control stations in a star network topology, which consists of a “central” node, i.e., the shore station of the VDE-TER infrastructure, to which all other nodes, i.e., the mobile stations are connected; the shore station provides a common connection point for all mobile stations (see Fig. 2). The network-originated message is communicated from a shore station over the *downlink* to the mobile station(s), and the mobile-originated message is communicated over the *uplink* to the shore station. The uplink is thus a many-to-one communication link (i.e., multiple transmitters with one receiver), through which multiple mobile stations share the link in a TDMA fashion, following the slotted transmission timeline depicted in Fig. 14, however, under a centralized medium access control by the shore station.

Therefore, the signals received by the shore station are from multiple mobile stations with varying propagation delays depending on the mobile station distance to the shore station, of which the maximum difference is ~ 0.3 ms (assuming a 50-NM cell radius). This discrepancy necessitates a time buffer of at least 0.7 ms on the uplink to avoid overlapping between successive transmissions from different mobile stations. The analysis of the actual time buffer needed for absorbing the propagation delay and timing errors is deferred to the physical layer of this section. In the opposite direction (from a shore station to different mobile stations), the downlink is one-to-many (i.e., one transmitter with many receivers), and thus a time buffer is not needed.

1) *Mobile Station Categorization*: To address the various maritime requirements more efficiently for various types of applications and use cases, in the current design, the mobile stations that serve these communication needs are classified into different categories in terms of their communication capabilities:

Category 1: This type of mobile station allows for bi-directional communications, but cannot be paged either through PCH or through ACH by the network. They operate only on a half-duplex mode with low transmit power (100 mW or higher), and wake up only when *uplink* application data arrive. The only chance for the network to transmit downlink data to the device is the time window reserved for downlink transmission, where the mobile station is expected to listen in on ACH right after the uplink data transmission is completed. Only QPSK modulation is supported for transmit

TABLE VII
NETWORK LAYER SYSTEM BULLETIN BOARD PDU FORMAT

FIELD	BIT WIDTH
MMSI of control station	30
Bulletin Board version validity	16
System version	4
Frame configuration	9
Timing configuration	4
Transmit power	4
Target receive power	6
Neighbor list	4×8
System information block	9
Reserved	78
Total	192

power amplifier efficiency. Consequently, this type of station has the most relaxed downlink latency requirement, but is the most power-efficient, and hence ideal for battery-operated or energy-harvesting maritime IoT devices.

Category 2: This category of the mobile station is the same as Category 1, except that it can be paged by the network via PCH for pending downlink data, thereby resulting in reduced downlink latency. Like Category 1 mobile stations, it is limited to half-duplex communication.

Category 3: This category of mobile station is the same as Category 2, except that it has higher transmit power (>400 mW), supports full-duplex operation, and has the capability of higher-order modulation, i.e., 16-QAM.

Category 4: This mobile station type is the same as Category 3, except that its pending downlink messages are not notified through PCH. Instead, it continuously monitors the downlink assignment channel, ACH, for downlink data destined to it on the traffic channel, DTCH, which eliminates the paging delay at the cost of power-efficiency. It also has the capability of higher-order modulation (64 QAM) that requires a transceiver of less than 8% EVM (i.e., error vector magnitude). Mobile stations of this type have the highest transmit power (e.g., 1W), and are typically provided with continuous power supply.

2) *Network Layer:* A System Bulletin Board PDU from the network layer includes the primary system information, including radio frequencies and bandwidths of uplink and downlink channels, and current frame configuration. It is defined in Table VII.

The frame configuration field in BBCH allows 512 predefined frame configurations. As such, a frame can be configured for FDD and TDD transmissions using the resource block concept as shown in Fig. 17. Fig. 18 is a configuration example for FDD. By controlling the resource block size, the network can balance coverage, transmission latency, and system overhead as needed, including the choice of different bandwidths for different channel conditions [38]. For TDD, by partitioning the uplink and downlink resources in a frame, the network can accommodate asymmetric uplink and downlink traffic loads.

The MMSI field contains the identifier of the current control station, and the Bulletin Board validity field indicates the

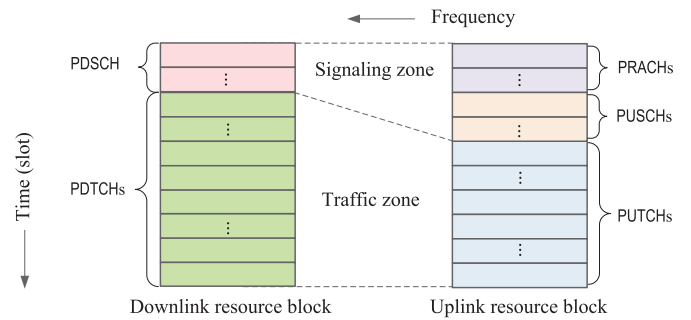

Fig. 17. The concept of resource block to simplify data transmissions under centralized resource control.

lifetime of the current Bulletin Board, which can be up to 2^{16} minutes or 45 days. Furthermore, the system version represents the release version number of the VDES currently in use.

The transmit power and target receive power at the control station are used for power control during initial random access, which is treated in Section V-C.

The neighbor list contains eight indices to the scramble sequences used by the eight neighboring control stations for PBBCH scrambling, as will be discussed later, for monitoring interference from neighboring control stations. If necessary, e.g., significant interference from a nearby control station is identified, the information is reported to the network NRC via a network layer Control PDU for potential coordinated transmissions with the interfering cell and, possibly, handover.

Finally, a valid (i.e., non-zero) system information block pointer points to the resource block that contains additional system information or announcements, if so needed.

The latest valid Bulletin Board message that is received by a mobile station is instigated in the frame immediately following the frame in which it is received.

3) *Data Link Layer:* We now turn our attention to the data link layer and focus on the MAC sublayer design under the proposed resource block framework.

Transmission Resource Block: A resource block module is introduced for ease of centralized medium access control, and more importantly, for ease of adaptation to various radio spectrum for better scalability and various types of deployments, including terrestrial and satellite deployments as well as FDD and TDD deployments. As depicted in Fig. 17, a resource block consists of a group of consecutive slots that are divided into a signaling zone and a traffic zone. The downlink signaling zone contains a PDSCH, and the traffic zone includes a plurality of PDTCHs. An uplink resource block contains a plurality of PRACHs and PUSCHs in the signaling zone, and a plurality of PUTCHs in the traffic zone, shared among multiple mobile stations. The definitions of these layer channels are given in Section IV-B.

In general, the configuration of the resource block, i.e., the actual size of the resource block and the TTIs of the respective signaling channels, i.e., PDSCH, PUSCH, and PRACH, are inferred from the frame configuration field of the System Bulletin Board. However, the TTI of PUSCH can be dynamically altered via CCCH. The traffic channels, i.e., PDTCH and PUTCH, are dynamically configured through ACH.

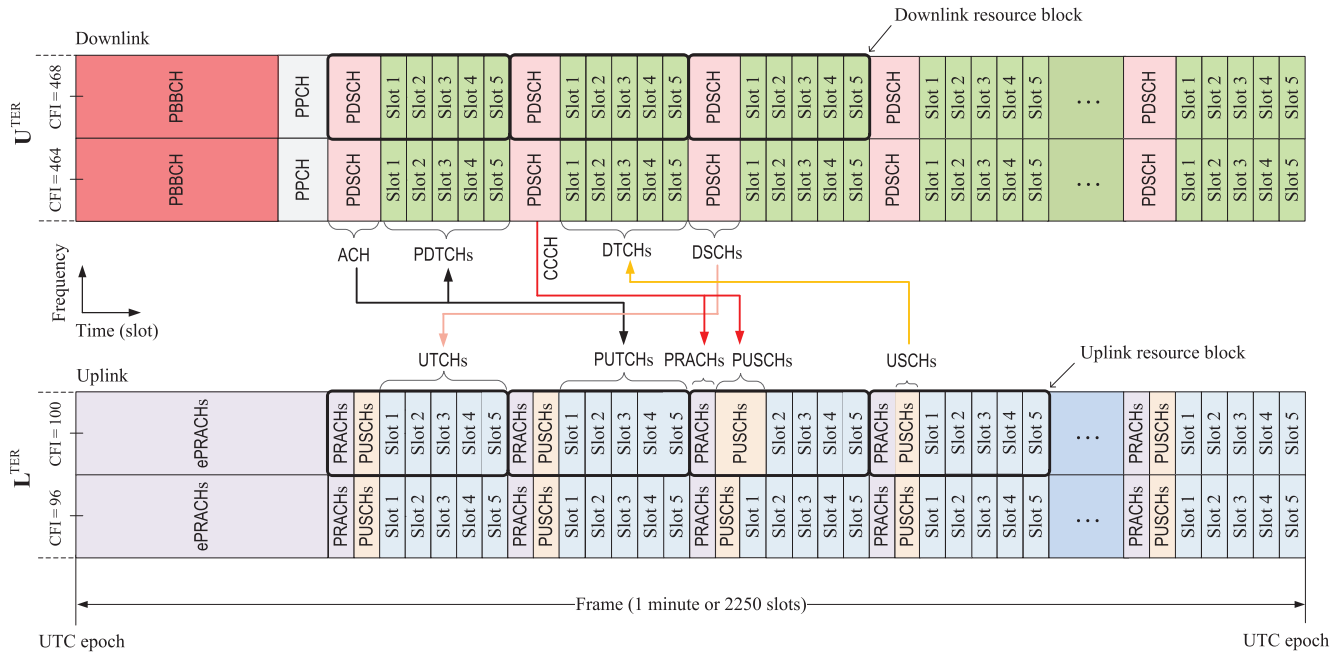

Fig. 18. A sample configuration of VDE-TER downlink and uplink frames operating in FDD mode to illustrate the resource block pairing concept for centralized resource scheduling and transmission ARQ, where the arrow indicates the association between the channels.

A downlink resource block and an uplink resource block are implicitly paired, such that the logical association between these channels involved in a transmission can be clearly defined. We use the example in Fig. 18 to illustrate such a concept, where the slots in a frame are organized into multiple resource blocks, in each of which the traffic zone of a resource block contains five slots for both uplink and downlink.

Resource Assignment: To enable centralized resource scheduling, the MAC resource allocation function, i.e., the scheduler uses Resource Assignment PDU, carried by ACH and transmitted on PDSCH, to commute the resource assignment information to the mobile station peers. In the current design, it is through the use of the *assignment element*. At the finest granularity level, slots in the traffic zone of the resource block pair are *individually* assigned to mobile stations as the resource for PTCH (PDTCH or PUTCH) indicated by an assignment element included in the Resource Assignment MAC PDU. In general, the assignment granularity can be more than one slot and is configured through the frame configuration field of the System Bulletin Board.

The definition of the assignment element is shown in Table VIII.A. An assignment element includes an MMSI, an SDU size, a power adjustment (PA), a timing adjustment (TA), and a new data (ND) indicator. The MMSI field contains the destined mobile station MMSI of the TCH. Recall that a valid ITU MMSI ranges from 0 to 999,999,999, and hence an assignment element with an MMSI value of 1,000,000,000 is designated to a broadcasting TCH. Similarly, an assignment element with an MMSI value of 1,000,000,001 represents a *void* assignment element that can be used as a place holder.

The new data field indicates if the TCH that the PTCH carries is a re-transmission or not. The power adjustment field is meant for the MAC power control function to instruct

TABLE VIII.A
ASSIGNMENT ELEMENT FORMAT A

Field	MMSI	SDUsize	ND	PA	TA	Continuation
Bit width	30	5 LSBs	1	2	2	1

TABLE VIII.B
ASSIGNMENT ELEMENT FORMAT B

Field	MMSI	SDUsize	Reserved	Continuation
Bit width	30	5 MSBs	5	1

the mobile station to adjust its transmit power for its next uplink transmission, for example, the acknowledgment of the PDTCH transmitted on PUSCH.

The SDU size field contains an index into a predefined SDU-size table that stores up to 1024 SDU sizes in ascending order. A 5-bit field, representing the five least significant bits (LSBs) of the table index, can thus index 32 smallest SDU sizes in the table.

Each of these individual slots can be a PTCH or part of a larger PTCH that consists of more than one slot. For example, the UTCH of a mobile station is assigned a 2-slot PUTCH (i.e., the TTI of the PUTCH spans two slots) when receiving two assignment elements destined to it. A continuation bit is included in the first assignment element to flag this scenario. If true, i.e., “1”, the subsequent assignment element is a continuation of the current assignment element, which contains the five most significant bits (MSBs) of the SDU size, as shown in Table VIII.B, thereby constituting a 10-bit index capable of indexing the entire SDU-size table. A larger PTCH can be configured using the continuation bit.

The PTCH is identified by the same index of the slot that the PTCH occupies, whereas the index of the TCH is inherited from the PTCH. For TTIs of more than one slot, they are identified by the index of the first assigned slot.

TABLE VIII
MAC RESOURCE ASSIGNMENT PDU (FOR CONFIGURATION IN FIG. 18)

Field	Bit width	Remarks
Assignment element	41	Downlink: Slot 1
Assignment element	41	Downlink: Slot 2
Assignment element	41	Downlink: Slot 3
Assignment element	41	Downlink: Slot 4
Assignment element	41	Downlink: Slot 5
Assignment element	41	Uplink: Slot 1
Assignment element	41	Uplink: Slot 2
Assignment element	41	Uplink: Slot 3
Assignment element	41	Uplink: Slot 4
Assignment element	41	Uplink: Slot 5
Total	410	Total bits

TABLE IX
MAC ARQ PDUs (FOR THE FRAME CONFIGURATION IN FIG. 18)

MAC function	Bit width	Field
Control station acknowledgements	1	ACK/NACK on UTCH of uplink Slot 1
	1	ACK/NACK on UTCH of uplink Slot 2
	1	ACK/NACK on UTCH of uplink Slot 3
	1	ACK/NACK on UTCH of uplink Slot 4
	1	ACK/NACK on UTCH of uplink Slot 5
Mobile station acknowledgement	1	ACK/NACK on the respective DTCH
	4	Downlink channel quality indicator
	1	Uplink resource scheduling request

Transmission Error Control: The transmission error control mechanism, i.e., ARQ, is also structured under the same resource block pairing framework and managed by a MAC ARQ function. As tabulated in Table IX, the acknowledgment of the reception of the DTCH transmitted on the PDTCH of the corresponding downlink resource block is via the MAC Acknowledgment PDU through USCH and transmitted on the PUSCH of the uplink resource block. The TTI of the PUSCH is configured by the MAC Resource Configuration PDU via CCCH (see Table X).

Similarly, the response to the reception of the respective UTCH, transmitted on the PUTCH of the corresponding uplink resource block, is controlled by the MAC ARQ function via the Mobile Feedback PDU through DSCH (Table IX), and transmitted on the PDSCH, along with ACH and CCCH.

Random Access: The random-access function of MAC enables a mobile station to access the network's transmission resource without being scheduled first by the network. A mobile station may also use this function to obtain the network timing.

The MAC Signaling PDU for random access is transported via RACH. Table XI is the format of such a Random Access PDU. It supports three types of messages: one for *uplink resource request*, one for *paging response* used by Categories 2 and 3 mobile stations, and one for explicit *network slot timing request*. All have the same PDU format: the MMSI of the requesting mobile station, and the pending PDU size for the requested uplink transmission on PUTCH, as well as the downlink channel quality

TABLE X
MAC RESOURCE CONFIGURATION PDU (FOR THE CONFIGURATION IN FIG. 18)

Field	Bit width	Remarks
PRACH TTI	3	PRACH TTI
PUSCH TTI	3	PUSCH TTI
Pilot pattern	2	Pilot pattern (except for the PDSCH bursts)
Total	8	Total bits

TABLE XI
RANDOM ACCESS MAC PDUs

MAC function	Field	Bit width
Uplink resource request	MMSI of mobile station	30
	Pending PDU size (value:1–63)	6
	Downlink channel quality indicator	4
Paging response / slot timing request	Mobile station category	2
	MMSI of mobile station	30
	Pending PDU size (value:0)	6
Total	Downlink channel quality indicator	4
	Mobile station category	2
Total		42

indicator for future downlink transmissions on PDTCH if needed, where a pending PDU size of zero naturally indicates a response to paging. When the response is sent by a mobile station that is not on the paging list, it is an indication for a network slot timing request. The network slot timing acquisition is presented in Section V-C.

The first slot(s) of each uplink resource block is reserved for PRACHs, and shared among mobile stations in a contention-based fashion. The actual number of slots is indicated by the MAC Resource Configuration PDU (Table X) transported via CCCH on the previous downlink resource block.

Paging: The MAC Paging PDU contains a list of MMSIs of mobile stations currently being paged for pending downlink data. It is transported via PCH and broadcast on PPCH located at the beginning of a frame (see Fig. 18). Once found in the list, a mobile station (Category 2 or 3) responds with a MAC Random Access PDU (pending PDU size = 0) through RACH and transmits it on one of the PRACHs randomly selected from the current frame. It then listens to the ACH for its downlink assignment on the following downlink resource blocks. Otherwise, the mobile station goes back to sleep until the next PPCH cycle.

4) *Physical Layer:* Built on the general framework presented above, the design of the VDE-TER physical layer strives to achieve the following general goals: 1) simplicity; 2) low-cost; 3) low latency; and 4) high overall system spectral efficiency. However, these goals are generally contradictory since the enhancement of one goal undermines the others. For example, simplicity, low-cost, and low latency typically come at the cost of overall system spectral efficiency. Hence trade-offs have to be made and can also be dynamically adjusted through frame configuration. The frame configuration field of BBCH provides up to 512 configurations for that purpose. Without loss of generality, for the given maritime MTC

spectrum (see Section III-C) and the maximum transmit power constraint, without overstressing the system and causing instability, the following design example targets coverage of 50 NM (~ 100 km) radius, and less than 1-second over-the-air transmission latency with minimized overhead to maintain overall sustainable system spectral efficiency. The maximum coverage of a shore station is upper-bounded by the radio horizon; here, we assume the shore station antenna is up to 250 meters tall, and the mobile station (e.g., a ship) is up to 100 meters.

Burst Bandwidth Selection: Although the VDE-TER spectrum is composed of multiple 25-kHz frequency channels, it does not necessarily mean it is the best bandwidth for the single-carrier waveform. On the one hand, the transmit bandwidth for each physical channel should be as large as possible (e.g., the maximum 100 kHz) to avoid splitting the band into multiple 25-kHz sub-bands to save the guard bands for separating these radio channels, recalling that the orthogonality between two adjacent carriers is protected by a guard band to avoid inter-carrier interference. On the other hand, a smaller bandwidth favors finer resource granularity, allowing scheduling more PUTCHs for more UTCHs of mobile stations on the uplink (many to one), efficient for short burst traffic. More importantly, a narrower band single-carrier waveform is also more likely to stay frequency-flat, i.e., more resilient to multipath effects without resort to an equalizer at the mobile receiver. Since the transmit power on an uplink physical channel is ultimately limited by the maximum power of a mobile station, dividing the uplink spectrum into smaller sub-bands for more PUTCHs allows more simultaneous transmitting mobile stations, meaning higher total transmit power on the uplink channels, and ergo higher overall spectral efficiency – especially true for low-power class (Category 1) mobile stations. Therefore, the default bandwidth is 50 kHz for both uplink and downlink – a balance among the above factors.

Link Budget Analysis: Remember that a physical channel is nothing but a set of slots for physically delivering logical channels over the air, with specific performance requirements depending on what type of logical channel it carries. Therefore, before delving into the design of the VDE-TER physical channels, let us take a look at the minimum receive signal-to-noise ratio (SNR) or sensitivity for each physical channel.

Both PDTCH and PUTCH rely on adaptive coding and modulation to various channel conditions, and the hybrid ARQ (HARQ) protocol [39] to ensure the reliability of transmissions through retransmissions as a result of a mismatch between the predicted channel used in the transmission and the actual channel. However, unlike these two traffic channels, the signaling channels (i.e., the downlink PBBCH, PPCH and PDSCH, and the uplink PUSCH and PRACH) do not have the luxury of HARQ, implying that the receiver only has one chance to decode the signaling message. Therefore, the signaling channels must be designed with sufficient reliability so that the signaling message is reliably received anywhere within the required coverage area, which may differ depending on the type of signaling signal. For example, PBBCH is typically required to be “visible” beyond the current cell boundary, i.e., visible from neighboring cells.

Assuming that the transmit power of a shore station is P_{shore} , the antenna gain G_{shore} , the maximum path loss L^{TER} , and the receiver antenna gain G_{mobile} , the corresponding receiver sensitivity is then $P_{\text{shore}} G_{\text{shore}} G_{\text{mobile}} / L^{\text{TER}}$. Further assuming the channel bandwidth is $B_{\text{DL}}^{\text{TER}}$, the noise power at the receiver is thus $\kappa T_{\text{mobile}} B_{\text{DL}}^{\text{TER}}$, where T_{mobile} is the noise temperature and κ the Boltzmann’s constant (i.e., -199 dBJ/K). However, as discussed in Section III-C, the VDE-TER spectrum is shared with the VDE-SAT downlink constrained by the PFD mask $\Psi(\theta)$ [2]. This interference from satellite downlink, denoted as $I_{\text{mobile}}^{\text{satellite}}(\theta)$, has to be taken into account in the VDE-TER link budget. The corresponding receiver SNR is, therefore,

$$\Gamma_{\text{mobile}}^{\text{shore}} = \frac{P_{\text{shore}} G_{\text{shore}} G_{\text{mobile}} / L^{\text{TER}}}{\kappa T_{\text{mobile}} B_{\text{DL}}^{\text{TER}} + I_{\text{mobile}}^{\text{satellite}}} \quad (7)$$

From the definition of the PFD mask, the PFD from the VDE-SAT space station impinging on the land is no greater than the PFD mask, i.e., $\Psi(\theta)$, $\theta \in [0^\circ, 90^\circ]$. Therefore, The corresponding interference power from a VDE-SAT space station collected by the mobile station receiving a VDE-TER signal is thus

$$I_{\text{mobile}}^{\text{satellite}}(\theta) = \lambda^2 (4\pi)^{-1} \cdot \Psi(\theta) \cdot G_{\text{mobile}}(\theta). \quad (8)$$

The maximum of (8) is

$$\begin{aligned} \hat{I}_{\text{mobile}}^{\text{satellite}} &\triangleq \max_{\theta \in [0^\circ, 90^\circ]} I_{\text{mobile}}^{\text{satellite}}(\theta) \\ &= -102 \text{ dBm}/50 \text{ kHz}. \end{aligned} \quad (9)$$

The 50-NM coverage corresponds to a maximum free space loss of 116 dB. Noting that in addition to free space loss, the terrestrial transmission channel at the VHF band also experiences a 24 dB *additional* path loss [40], giving rise to a total path loss $L^{\text{TER}} = 140$ dB. For VDE-TER downlink, the transmit power of a shore station is $P_{\text{shore}} = 5$ W and the antenna gain is $G_{\text{shore}} = 8$ dBi; the receiver sensitivity is then -98 dBm/50kHz, assuming the average antenna gain of a mobile station receiver is $G_{\text{mobile}} = -3$ dBi.

Since the default transmission bandwidth for VDE-TER is 50 kHz for both uplink and downlink, we have $B_{\text{DL}}^{\text{TER}} = B_{\text{UL}}^{\text{TER}} = 50$ kHz. Given the noise temperature of 30 dBK at the mobile station plus 5 dB to account for the additional interference from land, $T_{\text{mobile}} = 35$ dBK. The noise power is then $\kappa T_{\text{mobile}} B_{\text{DL}}^{\text{TER}} = -117$ dBm. The corresponding minimum downlink SNR from (7) is, therefore, $\Gamma_{\text{mobile}}^{\text{shore}} = 4$ dB.

Note that since the PBBCH of VDE-TER is also used as the beacon signal for spectrum sharing besides carrying BBCH, it is protected from the interference from the VDE-SAT downlink transmissions (see Section III-C) by design. Assuming the distance to the horizon is 50 NM, the sensitivity at the mobile station is then -98 dBm/50 kHz. Its corresponding minimum SNR is thus $\Gamma_{\text{mobile}}^{\text{PBBCH}} = 19$ dB.

As for the uplink, the mobile’s minimum transmit power is 100 mW (for a Category 1 mobile station). The receiver sensitivity is then -115 dBm/50kHz. The noise temperature of

the shore station receiver is typically $T_{\text{shore}} = 30$ dBK, corresponding to the noise power of $\kappa T_{\text{shore}} B_{\text{UL}}^{\text{TER}} = -122$ dBm, the receive uplink SNR is thus $\Gamma_{\text{shore}}^{\text{mobile}} = 7$ dB.

Physical Layer PDUs: As tabulated in Table XII, all downlink physical layer PDU provides a 24-bit CRC for integrity of the SDU. For the uplink, the CRC of the physical layer PDU depends on the type of the MAC PDU it carries. For physical layer PDU that carries MAC Traffic PDU, the same 24-bit CRC is used. For the PDU that carries the MAC Feedback PDU, a 6-bit CRC is used, and for MAC Random Access PDU, a 12-bit CRC is the default.

Downlink Physical Channels and Bursts: The downlink physical channel is transmitted over the air via a downlink transmission burst with a default bandwidth of 50 kHz, as depicted in Fig. 18. The burst employs a square-root raised cosine pulse with a roll-off factor of 0.3, at 38,400 channel symbols per second.

The construction of a downlink physical channel is similar to the PTCH of ASM, described in Section V-A. For signaling channels, like PBBCCH, PDSCH and PPCH, the MCS is fixed to 1/3 turbo code rate and QPSK modulation for best reliability, whereas for the traffic channel, i.e., PDTCH, the MCS is inferred from the SDU size and TTI by the MAC Resource Assignment PDU via ACH, based on the QoS of the MAC Traffic PDUs and the channel condition of the mobile station.

The System Bulletin Board message transported via BBCH is carried by a physical layer PDU and transmitted on the PBBCCH, as shown in Fig. 18. In the current design, PBBCCH is not configurable (i.e., fixed) for ease of system acquisition. However, additional system information, e.g., additional VDE-TER bands to allow scalability for future growth, can be broadcast as needed via a pointer embedded in the Bulletin Board (Table VII). In particular, the bandwidth of the PBBCCH is fixed to 50 kHz at carrier frequency indexes (CFIs) of 468 and 464, over an eight-slot TTI positioned at the very beginning of a downlink frame. As tabulated in Table XII, the required SNR at 1% SDU error rate (SER) is -13 dB (from simulation), whereas the minimum received SNR at a cell edge is 19 dB (from link budget). After taking into account the inter-cell interference at the cell edge, the SNR or SINR of PBBCCH becomes 0 dB, thereby boasting an extra 13 -dB processing gain for additional interference suppression capability needed for penetrating into neighboring cells. PBBCCH is the only downlink physical channel that is transmitted in a burst with a sync word, for the initial detection and synchronization to the serving control station by a mobile station. The sync word occupies 255 QPSK symbols, initialized with a 255×2 -bit all-zero sequence.

PDSCH carries a physical layer PDU that contains the MAC Signaling PDUs transported via CCCH, ACH, and DSCHs. It is configurable through the frame configuration field of the Bulletin Board. It enjoys an extra 4 -dB processing gain at the farthest cell edge for the current exemplary configuration in Fig. 18.

PPCH is dedicated to PCH that transports the MAC Paging PDU. It is configurable through the frame configuration field of the Bulletin Board. For the current example in Fig. 18, it has an extra 4 dB margin at the cell edge.

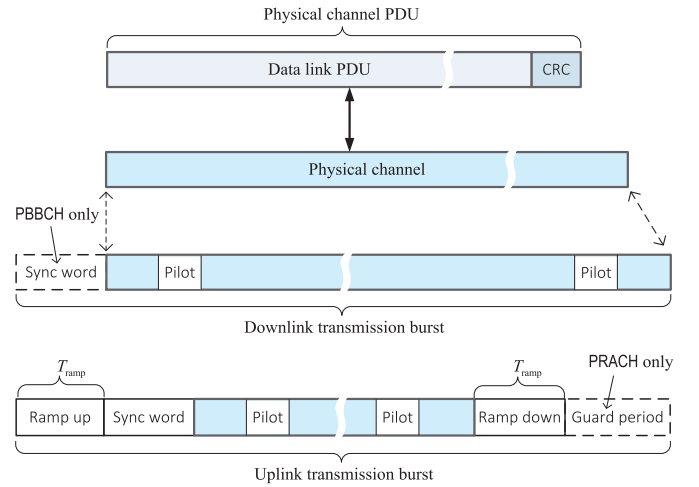

Fig. 19. VDE-TER and VDE-SAT transmission burst structures, where $T_{\text{ramp}} = 0.41$ ms, i.e., 16 symbols for VDE-TER and 14 symbols for VDE-SAT.

TABLE XII
VDE-TER SIGNALING CHANNELS LINK BUDGETS

Physical channel	Downlink			Uplink	
	PBBCCH	PPCH	PDSCH	PRACH	PUSCH
SDU (bits)	192	360	423	42	6
CRC (bits)	24	24	24	12	6
Code rate	1/3	1/3	1/3	1/3	4/7
Modulation	QPSK	QPSK	QPSK	QPSK	QPSK
TTI	8 slots	2 slots	2 slots	1 slot	1 slot
SNR (1% SER [†])	-13 dB	-5 dB	-5 dB	-9dB	-12 dB
Bandwidth	50 kHz	50 kHz	50 kHz	50 kHz	50 kHz
Transmit power	5 W / 12.5 W			100 mW / 1 W	
Noise temperature	35 dBK	35 dBK	35 dBK	30 dBK	30 dBK
Min. Receive SNR	19/23 dB	4/8 dB	4/8 dB	7/17 dB	7/17 dB
SINR ^{††}	0 dB	-1 dB	-1 dB	-6 dB	-6 dB

[†]SER: physical layer SDU Error Rate.

^{††}SINR: downlink: Signal to inter-cell Interference plus Noise Ratio at cell edge; uplink: Signal to inter-mobile (5 mobile stations) Interference plus Noise Ratio at a shore station.

Uplink Physical Channels and Bursts: As depicted in Fig. 19, the uplink physical channel is transmitted over the air via an uplink transmission burst with a default bandwidth of 50 kHz, same as the downlink. However, the uplink radio channel is shared by multiple stations in a TDMA fashion. The uplink burst thus has a ramp-up preamble and ramp-down postamble at each end of the burst, with duration $T_{\text{ramp}} = 0.41$ ms (16 symbols). Each burst also uses a sync word, enabling burst detection and synchronization at a control station, which occupies 31 QPSK symbols and is initialized with a 62-bit all-zero sequence.

The 50-NM communication range corresponds to a $\delta_{\text{MAX}} = 0.309$ ms one-way delay. The analysis of the required time buffer is similar to ASM, only that the transmitter is a mobile station and receiver a shore station. Under the centralized medium access control, the transmit timing of a mobile station is also controlled by the control station except for the initial transmission on PRACH. Consequently, as we will see later, a guard period is needed only for the PRACH burst. We thus require

$$T_{\text{buffer}} > \delta_{\text{MAX}} + 2|\epsilon_{\text{mobile}}| \quad (10)$$

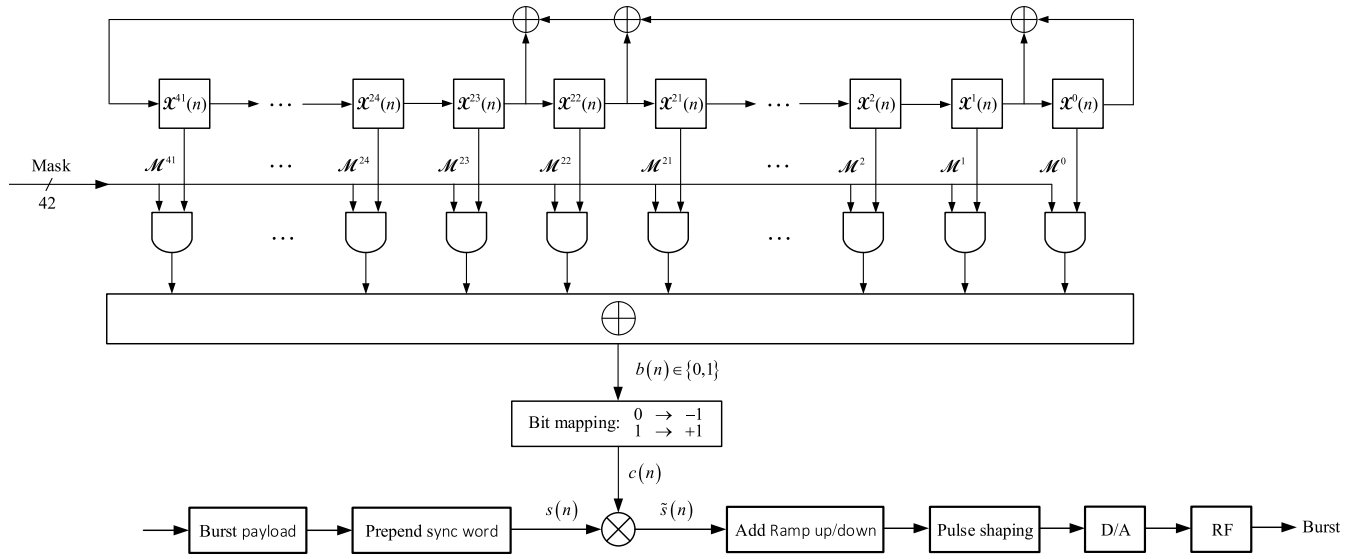

Fig. 20. Symbol scrambling for cell identification and interference suppression.

i.e., $T_{\text{buffer}} = 0.709$ ms for PRACH. After deducting the ramp-up and ramp-down periods, we still need a guard period,

$$\Delta_{\text{GP}}^{\text{PRACH}} = T_{\text{buffer}} - T_{\text{ramp}} \approx 0.3 \text{ ms} \quad (11)$$

or 12 symbols, at the end of the PRACH burst.

The pilot patterns for both uplink and downlink bursts are configurable dynamically according to the channel conditions of mobile stations by the pilot pattern field of the MAC Resource Configuration PDU via CCCH. A 2-bit pilot pattern field allows up to four pilot patterns.

Like the PDTCH, PUTCH is turbo-encoded, rate-matched, channel-interleaved, quadrature-modulated, and transmitted over the TTI, per the MAC Resource Assignment PDU communicated to the mobile station through ACH.

Like the downlink, both signaling channels are QPSK-modulated. For PRACH, the same turbo code is employed with a TTI indicated in the MAC Configuration PDU through CCCH of the previous downlink resource block. Since the resources for PRACH are shared among accessing mobile stations, the SINR after taking into account the co-channel interference still enjoys a 3-dB extra processing gain needed for suppressing the additional inter-mobile interference due to, e.g., imperfect open-loop power control as we will see later in this section. Also, as shown in Fig. 18, an extended PRACH with a 10-slot TTI is allocated at the very beginning of an uplink frame, denoted as ePRACH, providing an extra 10-dB boost in signal energy. Its primary purpose is to boost the PRACH energy for Category 1 mobile stations with limited transmit power.

PRACH is the only physical channel that has a guard period. The guard period for other uplink channels is eliminated through the MAC timing adjustment mechanism, which is treated in detail in Section V-C.

As for PUSCH, since the PDU carries a rather short 6-bit MAC Feedback PDU, it is encoded with a (7, 4)-Hamming

code. The coded bits are rate-matched, interleaved, and QPSK-modulated to fill up the entire payload of PUSCH. Similar to PRACH, PUSCH has a 6-dB extra processing gain for imperfect closed-loop power control as we will see in the next section. Nonetheless, unlike the PRACH, the sharing is only among mobile stations that acknowledge the reception of the corresponding DTCHs, and hence is not contention-based.

In order to reap the full benefit of the processing gain, randomization, or whitening of the physical channel signals is essential, which is commonly done through *discriminatory* scrambling.

Scrambling: In a multi-mobile, multi-control station, multi-frequency channel, multi-air interface, and spectrum-sharing deployment environment, like VDE-TER and VDE-SAT, interference management is crucial and challenging. The spectrum-sharing techniques have been discussed earlier as a primary means of interference mitigation. Nonetheless, residual interference or interference that cannot be avoided needs to be suppressed via, e.g., processing gain as well as interference diversity, which requires a special design at the physical waveform level.

Specifically, differentiation of physical channel waveforms across control stations, air interfaces, and frequency channels is necessary to avoid signal ambiguity (e.g., sync word and pilot signals between neighboring control stations); time-variance across transmission bursts must be embedded in the waveform to *create* “interference diversity” for robust interference suppression. As such, a symbol scrambling technique is employed in the current design in which all symbol streams in each transmission burst are scrambled with a discriminatory sequence, as depicted in Fig. 20.

Each modulation symbol in a sequence of N_{sym} modulation symbols of a transmission burst,

$$s(0), s(1), \dots, s(N_{\text{sym}} - 1), \quad (12)$$

is operated upon according to

$$\tilde{s}(n) = s(n) \cdot c(n), \quad n = 0, 1, \dots, N_{\text{sym}} - 1 \quad (13)$$

to produce a new symbol sequence

$$\tilde{s}(0), \tilde{s}(1), \dots, \tilde{s}(N_{\text{sym}} - 1), \quad (14)$$

where $c(n)$, $n = 0, 1, \dots, N_{\text{sym}} - 1$, is generated from the pseudo-random bit sequence, $b(n)$, $n = 0, 1, \dots, N_{\text{sym}} - 1$. Each bit of the sequence, $b(n)$, is generated by the modulo-2 inner product of a 42-bit mask

$$\mathcal{M} \triangleq [\mathcal{M}^{41} \dots \mathcal{M}^1 \mathcal{M}^0], \mathcal{M}^i \in \{0, 1\}, \quad (15)$$

and the 42-bit state vector

$$\mathcal{X}(n) \triangleq [\mathcal{X}^{41}(n) \dots \mathcal{X}^1(n) \mathcal{X}^0(n)], \mathcal{X}^i(n) \in \{0, 1\} \quad (16)$$

of a pseudo-random sequence generator as depicted in Fig. 20, where the pseudo-random sequence satisfies the linear recursion specified by the characteristic polynomial of

$$F(x) = x^{42} + x^{23} + x^{22} + x + 1. \quad (17)$$

The output pseudo-random bit sequence, $b(n)$, is then bit-mapped, where bit 0 is mapped to -1 and bit 1 to $+1$.

In order to create differentiation among air interfaces, control stations, and carriers, the 42-bit mask \mathcal{M} is specified by

$$\sum_{i=0}^{41} 2^i \cdot \mathcal{M}^i = n_{\text{SAT}} \cdot 2^{39} + n_{\text{MMSI}} \cdot 2^9 + n_{\text{CFI}}, \quad (18)$$

where n_{CFI} is the 9-bit CFI (0-482) of the occupied channel, and n_{MMSI} the 30-bit MMSI of the transmitting station. For VDE-TER, $n_{\text{SAT}} = 00$, for ASM, $n_{\text{SAT}} = 01$, whereas for VDE-SAT, $n_{\text{SAT}} = 11$.

To create a time-variance for interference diversity, the pseudo-random sequence generator is initialized with $\mathcal{X}(0)$, determined by

$$\sum_{i=0}^{41} 2^i \cdot \mathcal{X}^i(0) = n_{\text{slot}} \cdot 2^{11}, \quad (19)$$

where n_{slot} is the slot index (0-2249) of the *starting* slot occupied by the transmission burst.

To ease the system acquisition for a mobile station without the MMSI of the control station that it is accessing, for down-link bursts, and n_{MMSI} is selected from one of the predefined numbers, as listed in Table XIII, through neighboring cell interference coordination by NRC. This same fixed scrambling scheme applies to ASM bursts as well for the same reason only that n_{MMSI} is *randomly* selected or re-selected from the four candidates listed in Table XIII.

Similarly, to ease the PRACH detection for control stations, for the MAC Uplink Resource Request PDU and Slot Timing Request PDU, n_{MMSI} is randomly selected from one of the 64 predefined 30-bit numbers. There are 16 groups of such numbers, which are one-to-one associated with the 16 down-link burst scrambling sequences in TABLE XIII. These 64 by 16 numbers range from 1,000,000,000 to 1,000,001,023, and none is a valid MMSI. For the MAC Paging Response PDU, n_{MMSI} is the MMSI of the mobile station being paged.

Transmit Power Adjustment: When transmitting on the shared resources, transmit power control is critical to

TABLE XIII
EXAMPLES OF PREDEFINED n_{MMSI} FOR
VDE-TER, VDE-SAT, AND ASM

CFI	Index	n_{MMSI}
464 (VDE-TER)	0	0x 12200C43
	1	0x 1A43B1A8
	2	0x 0C2B9AF9

468 (VDE-TER)	15	0x 0B66BB25
	0	0x 24ED24AC
	1	0x 37D9E0BB
	2	0x 0CBD92D2
472 (VDE-SAT)
	15	0x 2A1B04A8
	0	0x 3B787680
	1	0x 0EBE3816
475 (ASM)	2	0x 1B2A38F7

	15	0x 32D14918
	0	0x 0EDC81FC
479 (ASM)	1	0x 365D71D5
	2	0x 35BD9CD8
	3	0x 0C6F61AA
	0	0x 0F36ABE5
479 (ASM)	1	0x 1687F4A5
	2	0x 21A64872
	3	0x 06AE3C4E

minimizing the near-far effect so that the channel capacity can be maximized.

When transmitting on the shared PUSCH resource, the mobile station is assumed to follow the power adjustment (PA) command piggybacked in the slot assignment element (Table VIII.A), to minimize the near-far effect among the PUSCH bursts that are transmitted on the same PUSCH slot(s) from different mobile stations. The main idea to reduce the near-far problem is to keep all PUSCHs received by the control station at the same power level just enough to decode the USCHs. To that end, the MAC ARQ of the shore station keeps an eye on the received power of the previous transmission from each mobile station (e.g., PRACH), based on which it instructs the mobile station to adjust its transmit power using the power adjustment command.

Like PUSCH, the PRACH burst resources are shared among mobile stations. However, interference control is more challenging than the PUSCH since there is no power control command or the like from the control station for the apparent reason: PRACH is meant for the mobile station's first attempt to communicate with the control station, and hence, unlike PUSCH, PRACH is contention-based – it is either unexpected (Uplink Resource Request) or partially unexpected (Paging Response) by the control station. So the burden is on the accessing mobile station (almost).

To figure out the transmit power for the PRACH burst independently, the random access function of the mobile station reckons that the ultimate goal is for the PRACH burst to reach the control station at a power level, P_{target} , just sufficient for it to decode the RACH. As such, after taking into account the extra power to compensate for the propagation path loss, L_{UL} , the transmit power is

$$P_{\text{MS}} = P_{\text{target}} + L_{\text{UL}} \text{ (dBm)}. \quad (20)$$

Since PRACH is the first attempted transmission, the mobile station has no way of knowing its uplink propagation loss, L_{UL} . However, this information can be derived from its counterpart, i.e., the downlink propagation loss, L_{DL} , knowing that

$$P_{CS} = L_{DL} + p_{MS} \text{ (dBm)}, \quad (21)$$

where P_{CS} is the control station transmit power, and p_{MS} is the received power at the mobile station. For FDD transmission mode, the radio channels for uplink and downlink are separated by almost 5 MHz; strictly speaking, they are not the same, but something to begin with when nothing else is available on the plate. The real problem is that the mobile station still has no knowledge of P_{target} and P_{CS} , however, known to the control station and hence are made available to mobile stations via the System Bulletin Board (see Table VII), broadcast through BBCH on PBBCH. We thus have

$$P_{MS} \approx P_{target} + L_{DL} = P_{target} + P_{CS} - p_{MS} \text{ (dBm)}. \quad (22)$$

However, depending on the radio channel, (22) may not be satisfied as mobile stations are power-limited, especially for Category 1 mobile stations. The actual transmit power is upper-bounded by the maximum transmit power, P_{MS}^{MAX} , i.e.,

$$P_{MS} = \min\left(P_{MS}^{MAX}, P_{target} + P_{CS} - p_{MS}\right) \text{ dBm}. \quad (23)$$

Therefore, there are ePRACHs in every frame reserved specifically for this scenario, where the transmit power-limited mobile stations may take advantage of the extended TTI (e.g., 10 slots) for sending PRACH on this extended PRACH resources with boosted signal energy, and equivalently, reduced target power by 10 dB.

Once detected, the shore station may assign a PUSCH with extended TTI to the requesting mobile stations via ACH.

C. VDE-SAT for Satellite MTC

Like VDE-TER, VDE-SAT employs centralized resource control (via space stations) and hence shares the same air interface design, including the same *unified* frame structure as VDE-TER, as seen in Fig. 20, but with several adjustments through transmission frame configuration to reflect the differences between VDE-SAT and VDE-TER, in radio spectrum, propagation delay, and link budget (if any). We thus focus only on these issues in this section.

1) *Link Budget Analysis*: It is critically important for system designers to address the conflicting demands of ensuring the resulting interference is within acceptable limits to the victim system, i.e., the co-frequency land systems, while at the same time providing an adequate signal level that offers reasonable data rates that are acceptable to the intended users, i.e., the maritime IoT services.

From Section III-C, the EIRP of a space station is constrained by $\Lambda^{satellite}(\phi)$ in Fig. 4. The corresponding power collected by an intended mobile station receiver per B_{DL}^{SAT} is thus

$$\rho_{mobile}^{satellite}(\theta) = \frac{\Lambda^{satellite}(\phi) \cdot G_{mobile} \cdot B_{DL}^{SAT}}{L^{SAT}(\phi)}, \quad (24)$$

TABLE XIV
VDE-SAT SIGNALING CHANNELS LINK BUDGETS

	Downlink			Uplink	
	PBBCH	PPCH	PDSCH	PRACH	PUSCH
Physical channel	PBBCH	PPCH	PDSCH	PRACH	PUSCH
SDU (bits)	192	1080	1253	42	6
CRC (bits)	24	24	24	12	6
Code rate	1/3	1/3	1/3	1/3	4/7
Modulation	QPSK	QPSK	QPSK	QPSK	QPSK
TTI	8 slots	2 slots	2 slots	1 slot	1 slot
SNR (1% SER)	-13 dB	-5 dB	-5 dB	-9 dB	-12 dB
Bandwidth (kHz)	50	150		50	50
Max. transmit power	126mW/50kHz			100mW/1W	
Noise temperature	30 dBK	30 dBK	30 dBK	26 dBK	26 dBK
Max. Receive SNR	11 dB	11 dB	11 dB	14/24 dB	14/24 dB
Min. Receive SNR	2 dB	2 dB	2 dB	5/15 dB	5/15 dB
SINR	-2 dB	-2 dB	-2 dB	-6 dB	-6 dB

where $\theta \in [0^\circ, 90^\circ]$ and $L^{SAT}(\phi)$ is the path loss between the space station and a receiver on the surface of the earth at a nadir offset angle of ϕ . $G_{mobile} = -3$ dBi (including the 3-dB polarization loss) is the average antenna gain of a Category 1 mobile station. The corresponding downlink receive SNR is

$$\begin{aligned} \Gamma_{mobile}^{satellite}(\theta) &= \frac{\rho_{mobile}^{satellite}(\theta)}{\kappa T_{mobile} B_{DL}^{SAT}} \\ &= \frac{\Lambda^{satellite}(\phi) \cdot G_{mobile}}{\kappa T_{mobile} L^{SAT}(\phi)}, \quad \theta \in [0^\circ, 90^\circ] \end{aligned} \quad (25)$$

where T_{mobile} is the receiver noise temperature of the mobile station.

Given the mobile station receiver noise temperature offshore, $T_{mobile} = 30$ dBK, the downlink receive SNR ranges from $\Gamma_{mobile}^{satellite}(\theta) = 2$ to 11 dB, corresponding to an elevation angle from $\theta = 90^\circ$ to 0° .

As for the uplink, given a radio bandwidth of $B_{UL}^{SAT} = 50$ -kHz and the minimum transmit power of 100 mW at a mobile station, the receive SNR at a space station can be calculated as

$$\Gamma_{satellite}^{mobile}(\theta) = \frac{P_{mobile} \cdot G_{mobile} \cdot G_{satellite}(\theta)}{\kappa T_{satellite} B_{UL}^{SAT} \cdot L^{SAT}(\phi)}, \quad \theta \in [0^\circ, 90^\circ], \quad (26)$$

where P_{mobile} is the transmit power of a mobile station, $G_{satellite}(\theta)$ is the antenna gain of a space station, and $T_{satellite} = 26$ dBK is the noise temperature of a space station receiver. The receive SNR ranges from 5 to 14 dB for a Yagi antenna.

Table XIV summarizes the link budget analysis results.

2) *Burst Bandwidth Selection*: In the frequency domain, a frequency guard band of 4 kHz is necessary to cope with the maximum Doppler shift of ± 4 kHz in the VHF band induced by a LEO satellite space station travelling at a speed of 8 km/s. This overhead further justifies the maximization of the waveform bandwidth offered by the VDE-SAT spectrum to minimize the guard band overhead. And yet, unlike in VDE-TER where the single-carrier waveform is upper-limited by the frequency-selectivity of the channel, it is typically

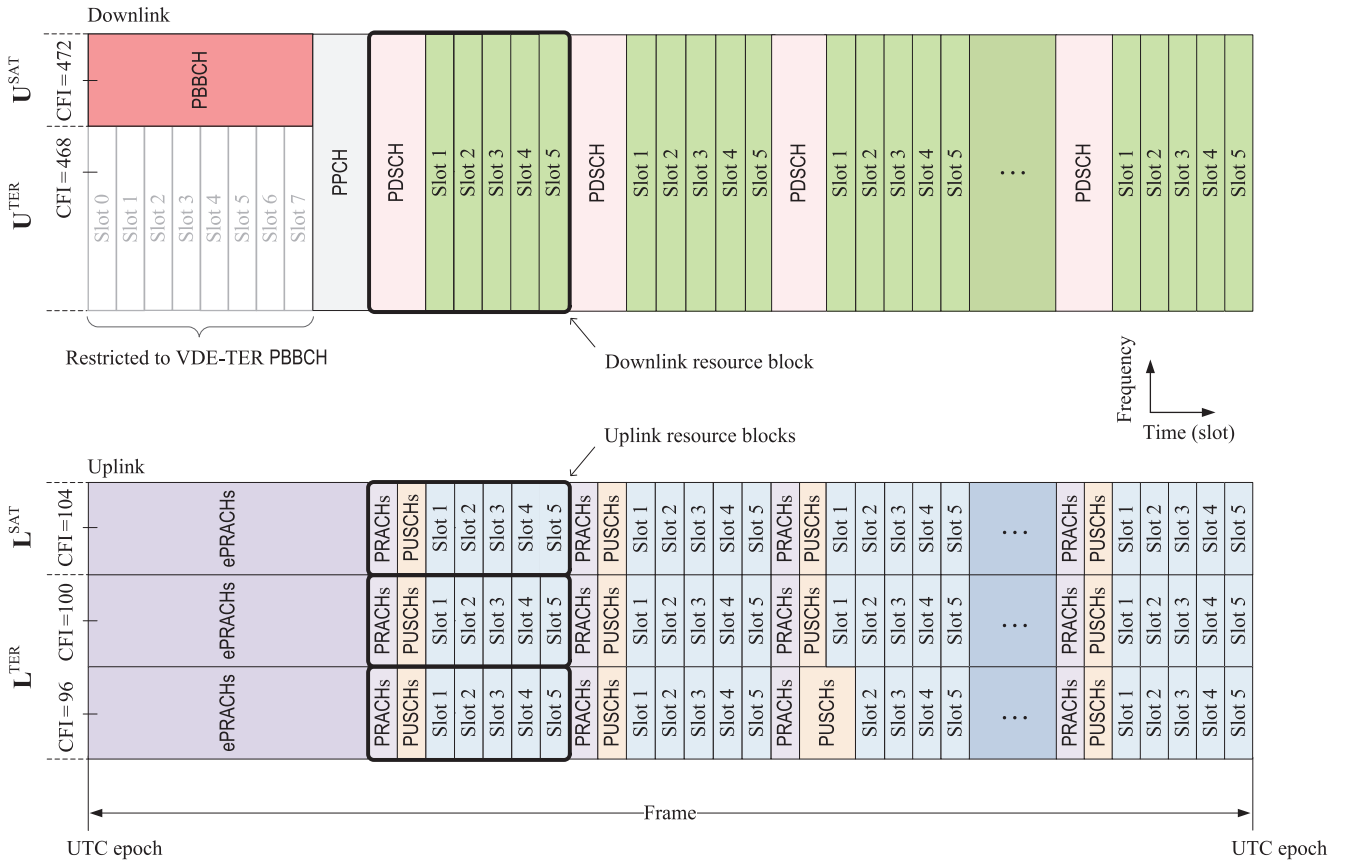

Fig. 21. Illustration of VDE-SAT FDD frame structure. The resource block pair association is the same as illustrated in Fig. 18.

not an issue for line-of-sight dominant satellite radio channels. Therefore, under the spectrum sharing scheme discussed in Section III-C, the downlink waveform takes the entire available bandwidth, i.e., 150 kHz, with 50 kHz from the dedicated VDE-SAT spectrum plus 100 kHz from the VDE-TER spectrum. The uplink remains 50 kHz a piece for resource granularity, regardless of the increased available bandwidth, as noted in Section V-B. The frame structure is exemplified in Fig. 21.

To allow for the same PDTCH resource granularity as the VDE-TER, there is a need to have more than one DTCH be bundled into a single PDTCH for a slot configured with a bandwidth greater than 50 kHz, e.g., 150-kHz. In that case, a slot may be assigned to three mobile stations, resulting in three assignment elements per slot. In the case that a downlink slot is assigned to the same mobile station, the mobile station will receive three duplicated assignment elements in a roll. Now that the number of mobile stations on the uplink is also tripled, a MAC Slot Assignment PDU thus contains tripled total number of assignment elements.

Using the square-root raised-cosine pulse with a roll-off factor 0.25, the transmit rate is 112,800 pulses or symbols per sec over a 150 kHz downlink spectrum, and 33,600 symbols per second over a 50-kHz uplink bandwidth, minus the 4-kHz guard band on each side of both uplink and downlink bands.

3) *Transmit Timing Adjustment*: Similar to VDE-TER, the uplink radio channel is shared among mobile stations in a TDMA fashion. During the uplink transmission period, the

uplink bursts received by the space station are from multiple time-division-multiplexed mobile stations with varying time delays, $\delta(\phi) \in [\delta_{\text{MIN}}, \delta_{\text{MAX}})$, depending on the off-nadir angle, ϕ , and thereby potentially overlap in time, causing co-channel interference among uplink bursts at the space station. Therefore, a time buffer of $T_{\text{buffer}} = \delta_{\text{MAX}} - \delta_{\text{MIN}}$ needs to be set aside for each burst to avoid collisions between mobile stations. Therefore, depending on the orbital height of the space station, a minimum time buffer of 8 ms (for the 600-kHz LEO orbit) is needed to avoid overlapping between successive uplink transmissions, corresponding to 30 percent of a slot.

However, ideally, if we time-align all uplink bursts arriving at the receiving space station, the uplink guard period, a minimum 30 percent of a slot overhead, can then be avoided. Furthermore, the reduced timing ambiguity at the space station improves the detection performance of the uplink burst. It is achieved by advancing the transmit time of the mobile station by such an amount just enough to offset its propagation delay, $\delta(\phi)$, as illustrated in Fig. 22. This delay is a function of the mobile station position relative to the space station (i.e., a function of ϕ) and time-varying. Hence it needs to be estimated on the fly.

Mobile Stations With UTC: A mobile station thus measures the one-way propagation delay, δ , by detecting the timing of the downlink signal (e.g., PBBCCH and PDSCH) against the UTC slot timing. A mobile station uses the estimated δ and advances its uplink transmission timing by $\Delta_{\text{TA}} = \delta$ relative

to the UTC so that the one-way propagation delay on the uplink is pre-compensated. This pre-compensation ensures the arrival time of the uplink signal in alignment with the system transmission timeline at the space station.

In practice, the timing advance error, i.e., the accuracy of the alignment of uplink bursts at a space station after timing advance at mobile stations is determined by the estimation accuracy of δ , which is in turn determined by: 1) the UTC synchronization accuracy at both mobile and space stations; 2) detection accuracy of the downlink signal timing by the mobile station; and 3) mobility of the space and mobile stations. It can be shown that the timing advance error can be upper-bounded by

$$|\varepsilon_{TA}| \leq 2(|\varepsilon_{\text{mobile}}| + |\varepsilon_{\text{satellite}}|) + |\varepsilon_d| + |\varepsilon_m|, \quad (27)$$

where, as noted earlier, $|\varepsilon_{\text{satellite}}| < 50 \mu\text{s}$ for a space station, and $|\varepsilon_{\text{mobile}}| < 200 \mu\text{s}$ for a mobile station, ε_d is the downlink timing detection error and is assumed to be well within one pulse interval, e.g., $|\varepsilon_d| < 5 \mu\text{s}$ for 150 kHz bandwidth and $15 \mu\text{s}$ for 50 kHz. Since there is a delay, Δt , between the measurement of δ and the application of δ , the relative movement between the mobile and space station within this duration may introduce a change in ϕ , and hence a change in $\delta(\phi)$, i.e., ε_m .

Indeed, the timing error introduced by the space station mobility over a period, Δt , is

$$\varepsilon_m(\phi) = \frac{1}{|\mathbf{c}|} |\mathbf{c} \cdot \delta(\phi) + \mathbf{v} \cdot \Delta t| - |\mathbf{c} \cdot \delta(\phi)| \quad (28)$$

where \mathbf{c} and \mathbf{v} are the velocities of the radio waveform and the space station, respectively. Since $|\mathbf{v} \cdot \Delta t| \ll |\mathbf{c} \cdot \delta(\phi)|$, we have

$$\begin{aligned} \varepsilon_m(\phi) &\approx \frac{|\mathbf{v} \cdot \mathbf{c}|}{|\mathbf{c}|^2} \cdot \Delta t \\ &\leq \frac{|\mathbf{v}|}{|\mathbf{c}|} \sin \phi_{\text{horizon}} \cdot \Delta t. \end{aligned} \quad (29)$$

Under the resource block pair configuration in Fig. 21, $\Delta t \leq 7T_{\text{slot}} = 187 \text{ ms}$. Given the LEO space station orbital speed $|\mathbf{v}| = 8 \text{ km/s}$, and $\phi_{\text{horizon}} = 66^\circ$ (see Fig. 4), we have $|\varepsilon_m| < 5 \mu\text{s}$.

The timing advance error for the *initial* uplink transmission on PRACH is thus $|\varepsilon_{TA}| < 510 \mu\text{s}$, which warrants a time buffer of $T_{\text{buffer}} = 2|\varepsilon_{TA}| = 1020 \mu\text{s}$, corresponding to a guard period

$$\Delta_{\text{GP}}^{\text{PRACH}} = T_{\text{buffer}} - T_{\text{ramp}}, \quad (30)$$

which is about 0.6 ms or 20 symbols to absorb the timing advance error, reducing the guard period to 2 percent.

Clearly from (27),

$$2(|\varepsilon_{\text{mobile}}| + |\varepsilon_{\text{satellite}}|) \gg |\varepsilon_d| + |\varepsilon_m|, \quad (31)$$

i.e., the timing advance error is dominated by the synchronization error. This synchronization error becomes much larger when UTC is not available.

Mobile Stations Without UTC: In the event that UTC is interrupted due to GPS outage or simply a lack of a GPS receiver (most likely true for Category 1 mobile stations),

TABLE XV
MAC TIMING ADJUSTMENT PDU

Header		SDU		
Type	Control function	MMSI	Propagation delay	Reserved
1	0000001	30 bits	9 bits	1 bit

a mobile station has to rely on the control station to acquire an indirect or derived UTC from, before engaging in communication with the control station.

As such, a mobile station first acquires the timing from the downlink signal, which includes a one-way propagation delay, δ . Without a UTC for reference, the best that a mobile station could do is to stay with this timing for the uplink transmission. The space station would then see a two-way delay of 2δ , ranging from $2\delta_{\text{MIN}}$ to $2\delta_{\text{MAX}}$. A mobile station thus advances its uplink transmission by a minimum amount of $\Delta_{TA} = 2\delta_{\text{MIN}}$ with a $T_{\text{buffer}} = 2(\delta_{\text{MAX}} - \delta_{\text{MIN}})$ time buffer – a doubled time buffer as a penalty for not having a UTC. For a LEO space station orbiting at a 600-km altitude, it means a time buffer of $2 \times 8 \text{ ms}$, which would take up 60 percent of a slot, and gets even worse for higher orbit space stations.

It becomes evident that, in order not to bankrupt the uplink, it is imperative for a mobile station to have the correct timing before transmitting on the uplink. The MAC timing adjustment function is designed just for that purpose, by ensuring that mobile stations have the right transmit timing such that the uplink bursts are aligned with the network slot boundary at the space station, despite the propagation time differences among transmitting mobile stations.

To that end, mobile stations that do not have a UTC, for whatever reason, first acquires and *locks on* the downlink slot timing, $t_{\text{slot}}^{\text{DL}} = t_{\text{slot}} + \delta$, where t_{slot} is the network slot timing. Since δ is unknown, a good estimate to start with is $\delta^0 = \delta_{\text{MIN}}$, and the network slot timing is then $t_{\text{slot}}^0 = t_{\text{slot}}^{\text{DL}} - \delta^0$. The mobile station then transmits a PRACH burst on a PRACH resource, $\Delta_{TA}^0 = \delta^0$ in advance of the slot boundary t_{slot}^0 .

The space station estimates the timing error, ε_{TA}^0 , from the received PRACH, and appries the mobile station of this error via the Timing Adjustment MAC PDU, as shown in Table XV, transmitted via DSCH or DTCH on a PDTCH. The mobile station updates the one-way propagation delay based on the received ε_{TA}^0 , i.e.,

$$\delta^1 = \delta^0 + \varepsilon_{TA}^0 / 2, \quad (32)$$

and the current slot timing,

$$t_{\text{slot}}^1 = t_{\text{slot}}^{\text{DL}} - \delta^1. \quad (33)$$

With the updated slot timing and propagation delay, the mobile station advances its uplink transmit timing by $\Delta_{TA}^1 = \delta^1$ ahead of t_{slot}^1 for both PUSCH and PUSCH transmissions so that they are in alignment with the network slot timing at the space station.

Under this scheme, a $T_{\text{buffer}} = 2(\delta_{\text{MAX}} - \delta_{\text{MIN}})$ time buffer is needed for a PRACH burst to absorb the initial timing error, but is negated for both PUSCH and PUSCH bursts.

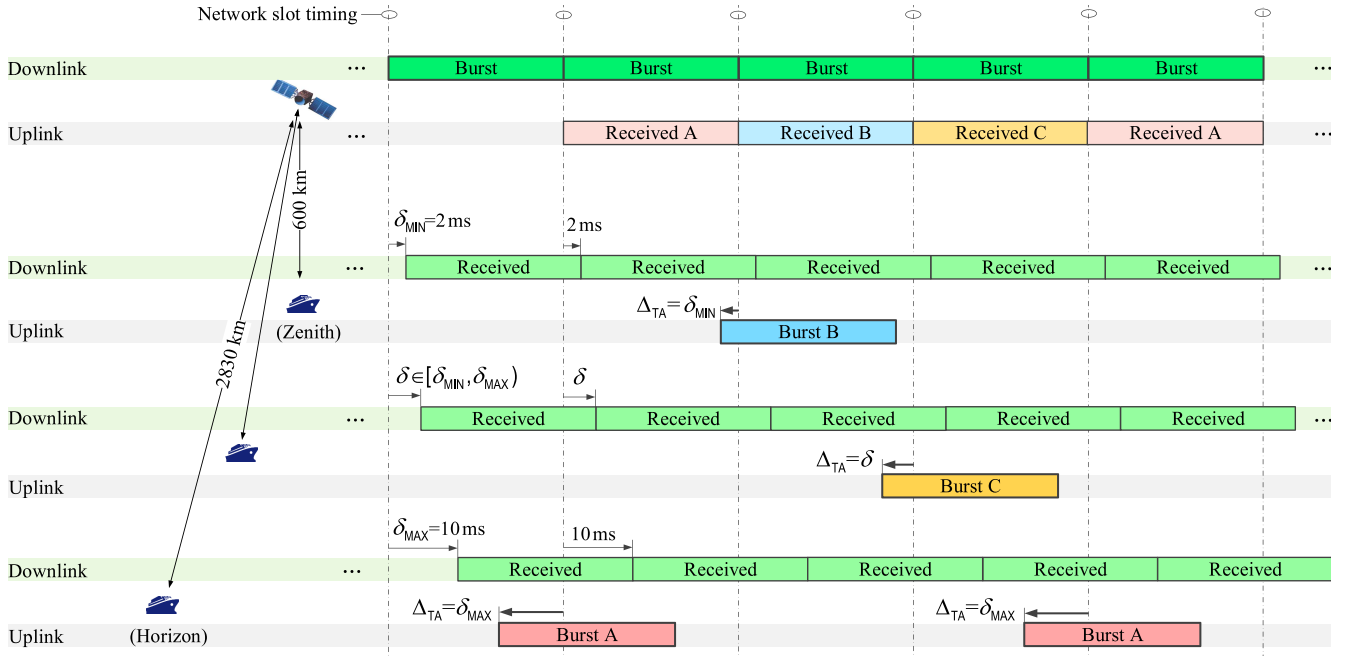

Fig. 22. Illustration of VDE-SAT transmission timing, where downlink transmissions by satellite are time-aligned with the UTC.

To track the propagation delay, the space station continuously monitors and evaluates the timing error, ε_{TA}^i ($i \geq 1$), every time an uplink burst is received, and updates the mobile station, as deemed necessary. If so instructed, the mobile station updates the propagation delay

$$\delta^i = \delta^{i-1} + \varepsilon_{TA}^{i-1} / 2, \quad (34)$$

and advances the timing of the pending uplink bursts by $\Delta_{TA}^i = \delta^i$ with respect to

$$t_{\text{slot}}^i = t_{\text{slot}}^{\text{DL}} - \delta^i, \quad (35)$$

to pre-compensate for the propagation delay.

Typically, $\varepsilon_{TA}^i \ll \varepsilon_{TA}^0$, for $i > 0$. Therefore, for the MAC timing adjustment function to get its message across more efficiently to its peer at the mobile station, for small timing offsets, the adjustment information is communicated to a mobile station via the timing adjustment (TA) field of the assignment element defined in Table VIII A. It is designed to offer a finer resolution, and is more time and resource-efficient than the full-blown one defined in Table XV, when dealing with smaller timing errors. The relationship between these two forms of MAC timing adjustment mechanism is complementary, rather than overriding. That means that when receiving both forms of updates from the MAC timing adjustment function of the control station, a mobile station executes both cumulatively.

There are two slight problems with this scheme, however. Firstly, a regular PRACH that has a one-slot TTI under the frame configuration in Fig. 21, and a

$$T_{\text{buffer}} = 2(\delta_{\text{MAX}} - \delta_{\text{MIN}}) + 2|\varepsilon_d| \quad (36)$$

time buffer, e.g., 16 ms, or a guard period, $T_{\text{buffer}} - T_{\text{ramp}} = 15.6$ ms, for a LEO space station corresponding to 60 percent of overhead, would be too wasteful, and

significantly reduce the PRACH resource capacity. Referring back again to Fig. 21, “luckily,” we have an ePRACH resource reserved at the beginning of a frame for PRACHs with extended TTI (10 slots) for power-limited mobile stations (e.g., Category 1 mobile stations). This extended PRACH resource is also ideal for this scenario since a $\Delta_{\text{GP}}^{\text{ePRACH}} = 15.6$ ms guard period is just six percent overhead for this ePRACH. A guard period of $\Delta_{\text{GP}}^{\text{PRACH}} = 0.6$ ms can then be retained for the regular PRACHs for mobile stations with UTC. For space stations with different orbital altitudes, the guard period of this ePRACH is configured through the frame configuration field of the Bulletin Board message.

Secondly, a guard period may not be eliminated for PUSCH or PUSCH due to 1) uplink timing detection error by the space station, and 2) mobility of the space station. Collectively, a time buffer T_{buffer} should be present to absorb

$$T_{\text{buffer}} \geq 2(|\varepsilon_d| + |\varepsilon_m|) + \tau_{TA} \quad (37)$$

where $|\varepsilon_d| < 15\mu\text{s}$, $|\varepsilon_m| < 15\mu\text{s}$ ($\Delta t = 20$ slots), and τ_{TA} is the MAC timing adjustment resolution.

With the 2-bit Timing Adjustment field in Table VIII A, we intend to provide a granularity τ_{TA} of a quarter of the time buffer, i.e., $\frac{1}{4} T_{\text{buffer}}$. Solving (37) for T_{buffer} and τ_{TA} , we obtain $T_{\text{buffer}} = 80 \mu\text{s}$, and $\tau_{TA} = 20 \mu\text{s}$. The Timing Adjustment PDU in Table XV for coarse adjustment is expected to provide a timing adjustment range of more than half a slot, and a granularity of T_{buffer} . The Timing Adjustment field thus requires a 9-bit width. A time buffer of $80 \mu\text{s}$ is thus sufficient for both PUSCH and PUSCH, which can be comfortably absorbed by the $T_{\text{ramp}} = 0.416$ ms of the burst. An extra guard period can thus be saved, i.e., $\Delta_{\text{GP}} = 0$ for both PUSCH and PUSCH bursts.

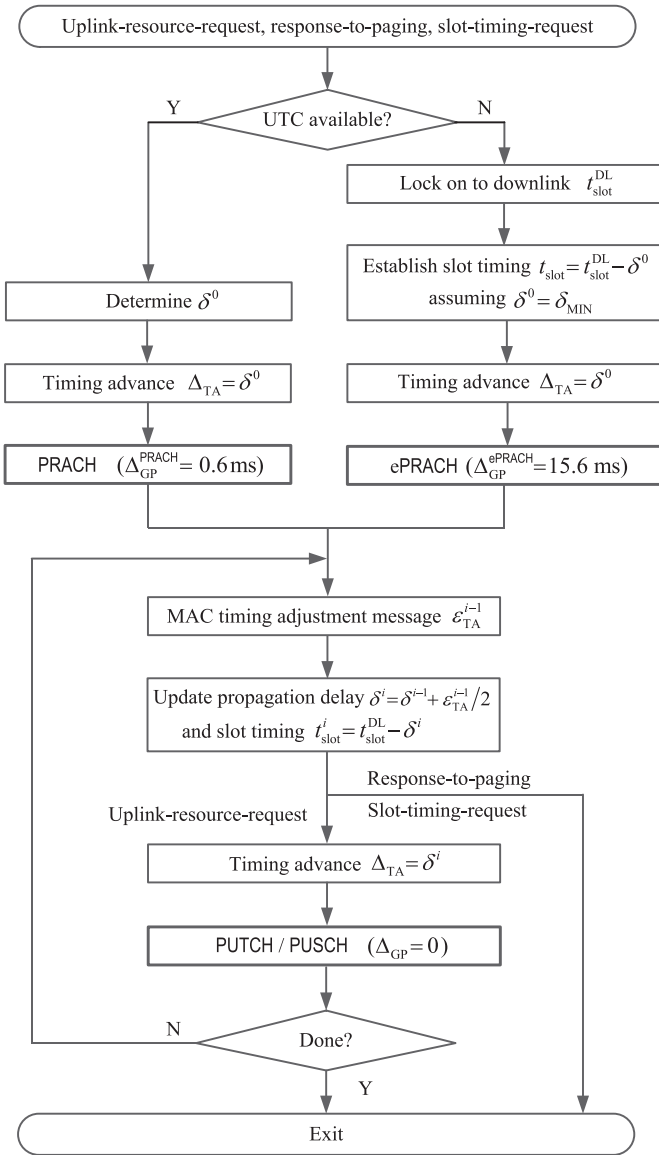

Fig. 23. Procedure for mobile station uplink resource request, response to paging, and slot timing request, where $i \geq 1$.

A flowchart that summarizes the timing process is given in Fig. 23.

When operating under indirect UTC timing, the timing advance derived from the most recent timing adjustment update may become stale as time elapses, due to, e.g., a lack of uplink activities, remembering that a timing adjustment update only ensues from the uplink burst successfully received by the control station. Therefore, in the case of prolonged uplink silence, a timing update may be needed through PRACH.

Finally, the same unified timing mechanism applies to VDE-TER transmissions as well, only that the propagation delay issue is not nearly as prominent as in VDE-SAT. As such, the guard period for ePRACH gets to remain the same as PRACH.

As noted earlier, ASM transmissions also share the same network slot timing. In the absence of UTC, the mobile station may synchronize to the slot timing by explicitly sending a MAC Random Access PDU (Section V-B) to its peer

for *network slot timing request*, via RACH on the PRACH (VDE-TER) or ePRACH (VDE-SAT). The control station will respond with a MAC Timing Adjustment PDU via DSCH or DTCH on PDTCH.

4) *TDD and Half-Duplex FDD Timing Structure*: Timing in TDD is similar to that in FDD, but with added complication resulting from the time-division-duplexed (TDM) transmissions between the uplink and downlink on the *same* radio channel.

First, we need to consider not only the potential temporal overlap between subsequent uplink bursts at a space station as we see in FDD but also at the transitions from downlink to uplink at a mobile station. It is because in FDD a space station has a dedicated radio channel, i.e., the downlink channel, and hence there is no conflict there, whereas in TDD the same radio channel is shared by both space station and mobile stations, meaning all stations, regardless control or mobile, share the same radio channel in a TDM fashion. Again, the solution is based on the same transmission timing framework for FDD with special care at the transitions.

Let us take a close look at the transitions between the downlink and uplink. Apparently, with the same FDD timing advance mechanism in place, the overlap issue at the transition from the uplink to downlink is taken care of automatically. However, as shown in Fig. 24, overlaps do happen at the transition from the downlink to uplink since a downlink burst does not have a time buffer. At a mobile station, the downlink burst protrudes into the period designated for uplink transmissions, due to the propagation delay from the space station to the mobile station. The protrusion gives rise to co-channel interference at the mobile station, blocking it from receiving downlink transmissions while transmitting on the uplink. Recall that TDD relies on “temporal separation” between the downlink and uplink to provide isolation against the cross-link interference. Any temporal overlap breaches the isolation.

A solution to this issue is to reserve a time gap at the transition from the downlink to uplink, large enough to absorb the downlink propagation delay plus the uplink timing advance, i.e., the uplink propagation delay.

Second, it takes time for a transceiver to switch from transmit to receive, τ_{T-R} , and from receive to transmit, τ_{R-T} . They are typically less than 100 μ s. Nonetheless, there is a need for an additional time gap at the transition from uplink to downlink as well.

However, these two time-gaps can be consolidated into a single one by leveraging the uplink timing advance scheme, i.e., increasing the uplink timing advance by an additional amount of time for switching from transmit to receive. Therefore, a time gap of

$$T_{\text{gap}} > \underbrace{\delta_{\text{MAX}}}_{\text{at space station}} + \underbrace{\delta_{\text{MAX}} + \tau_{R-T} + \tau_{T-R}}_{\text{at mobile station}} = 2\delta_{\text{MAX}} + \tau_{R-T} + \tau_{T-R} \quad (38)$$

guarantees no overlap at a space station or a mobile station, as well as ample switch time at both transitions. The first part of (38) is attributable to the uplink propagation delay seen at

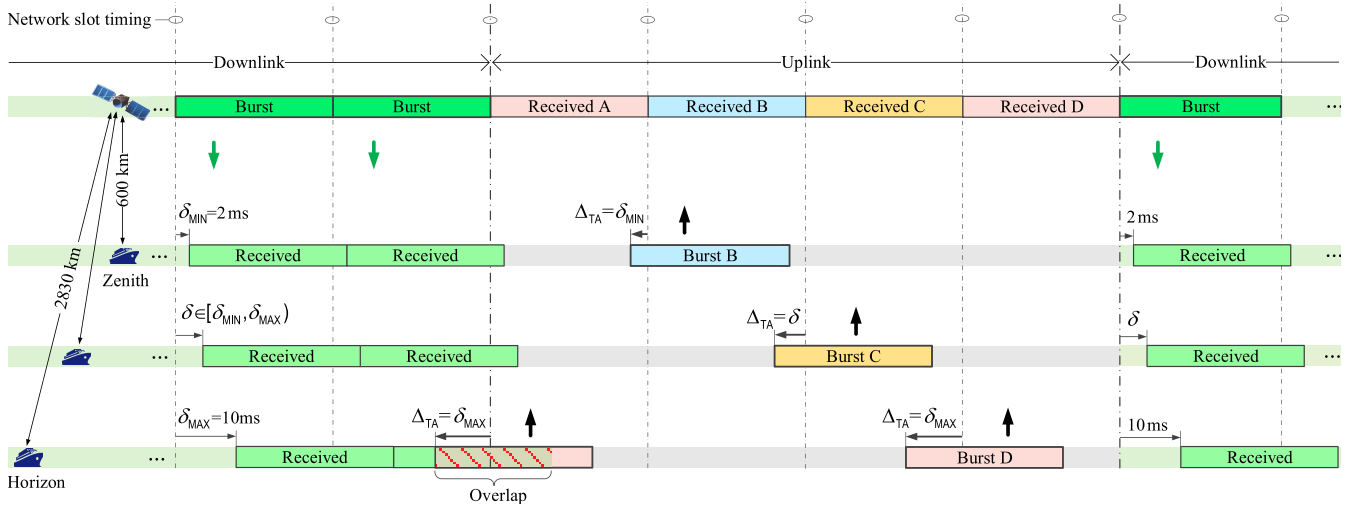

Fig. 24. Illustration of temporal overlap between downlink and uplink bursts at the downlink to uplink transition under TDD.

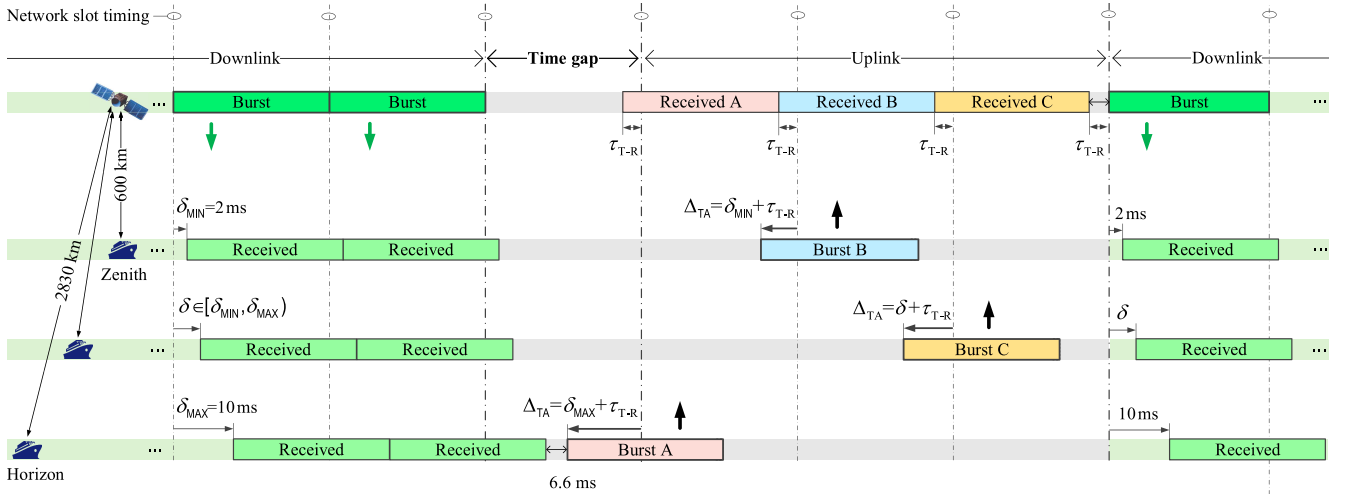

Fig. 25. Illustration of TDD transmission timing framework, where downlink transmissions by satellite are time-aligned with the UTC-based network slot timing, and a one-slot (80/3 ms) time gap is reserved at the downlink-to-uplink transition for absorbing *both* downlink and uplink propagation delays as well as the *switch time*, i.e., $2\delta_{\text{MAX}} + \tau_{\text{R-T}} + \tau_{\text{T-R}}$.

a space station, whereas the second part is attributable to the downlink propagation delay, as well as the switch time from receive to transmit and from transmit to receive, at a mobile station.

A one-slot worth of time gap provides a maximum propagation delay, δ_{MAX} , up to 13 ms per (38), sufficient for LEO space station at an altitude of 600 km. One slot is thus reserved as a time gap at every transition from the downlink to the uplink. A mobile station advances its uplink burst by δ plus an additional $\tau_{\text{T-R}} = 100 \mu\text{s}$, i.e., $\Delta_{\text{TA}} = \delta + \tau_{\text{T-R}}$. This gives a mobile station 100 μs for the transition from transmit to receive, and leaves at least $T_{\text{gap}} - (2\delta_{\text{MAX}} + \tau_{\text{T-R}}) \approx 6.6$ ms for the transition from receive to transmit, as shown in Fig. 25.

For orbital altitudes higher than 1,100 km, more than one slot is needed. Indeed, the need for such a time gap for buffering two-way delays is purely a cost incurred by the sharing of a radio channel between the downlink and uplink. In fact, the need for such a time gap is the most significant disadvantage

of TDD compared to its full-duplex FDD counterpart, and ultimately limits the switching frequency between downlink and uplink.

Half-duplex FDD is likely to be the default transmission method because of its simplicity. Like TDD, half-duplex FDD uses temporal separation between downlink and uplink to avoid temporal overlap between uplink and downlink transmissions for cross-link interference avoidance. Therefore, they share the same timing framework despite that, unlike TDD, half-duplex FDD uses separate radio channels for downlink and uplink transmissions.

VI. OPEN ISSUES AND POSSIBLE SOLUTIONS

The maritime MTC system presented so far promises the ubiquitous connectivity and service continuity for maritime IoT. While in the real world, it might only hold at the national or regional level, service continuity remains in question as soon as a mobile station moves out of its national network's

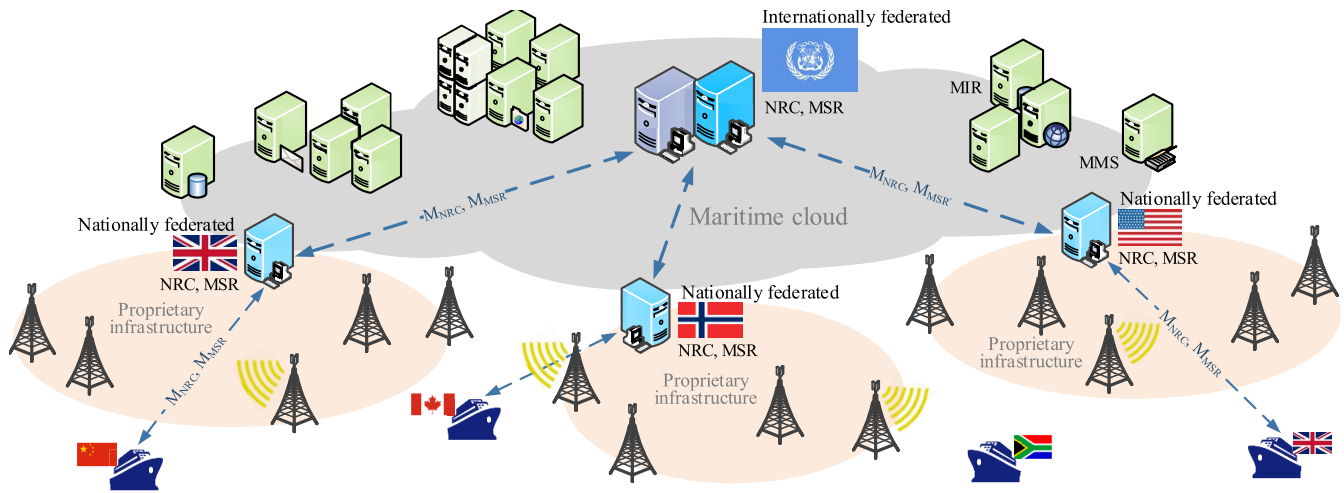

Fig. 26. Graphical illustration of a multi-nation maritime MTC network, where national-level MTC networks are typically proprietary networks, and are connected via standard interfaces to the internationally federated maritime service platform, e.g., MSR, to enable global MTC for maritime IoT. M_{NRC} and M_{MSR} denote the standard NRC and MSR protocol interfaces, respectively.

footprint. Indeed, control ownership and data privacy are among the leading concerns challenging the centralized controllability of the network architecture and ultimately plaguing the globalization of maritime IoT, and invalidating the very concept of the maritime IoT, i.e., the ubiquitous connectivity and service continuity.

Today's maritime communication systems comprise many isolated national and regional level systems that are typically proprietary infrastructures and protocols, where the network resources within the infrastructure are dedicated to a single organization, and accessed and controlled locally. They do not communicate to the outside maritime world, strange as it may seem, not even the neighboring countries. That means the network resource, configuration, and state information stay inside and not shared. Therefore, the maritime IoT network will likely continue as a collection of such non-communicating private networks until such time as there is an assurance of security from an internationally-federated maritime service platform under which information can be collected from and safely shared among these networks.

A network structure that resonates more with the reality is such a one that leverages the cloud service delivery approach under a multi-cloud maritime MTC structure. Under this approach, the proprietary maritime MTC network remains as a private cloud that owns its virtually isolated MTC solutions customized to its physical environment as well as its native service providers and clients while sharing the underlying proprietary infrastructure as a service with the global MTC network through virtual network functions that run on top of the private network infrastructure. This structure promotes the concept of platform-based services on cloud that hides the underlying infrastructure from the outside world and yet allows a service provider to efficiently extend its service beyond the boundaries of a physical network and continuously deliver carrier-grade trans-region connectivity and services to the transiting and visiting vessels.

Fig. 26 exemplifies such a two-tier multi-nation maritime MTC network architecture, where each national-level

proprietary infrastructure provides a gateway that functions as the Maritime Application Server and Network Controller of the national network and communicates through a standard interface (M_{NRC} and M_{MSR}) to the IMO-certified maritime service platform that serves as an internationally-federated Maritime Application Server and Network Controller. This architecture provides the architectural foundations that enable network information and service data to be accessed and shared appropriately and securely across organizational, regional, and national boundaries.

VII. CONCLUSION

Indeed, the most recent allocation of the international spectrum for maritime IoT has laid the foundation for the globalization of a low-cost maritime MTC technology. The international standardization of this technology is essential to guarantee compatibility, interoperability, repeatability, and sustainability. It is a process of developing and implementing technical standards based on the consensus of different parties that include stakeholders, manufacturers, interest groups, standards organizations, and government agents. The technology development and standardization thus require the culmination and synergy of various technological efforts. This new paradigm provides a unique opportunity for the terrestrial and maritime communities as well as the satellite community to join forces to establish a harmonized and fully-fledged space-earth communication network, differently from the past when these technologies evolved almost independently from each other.

However, maritime communications have been relegated to a lower priority tier for many decades, mainly because of the limited market and thin profit margins. This situation inevitably results in depleted genuinely-experienced professionals, retardation in communication technology, and failure to attract and retain a sufficient number of contributors. What could likely happen next is that some immature VDES technology is rushed into an international standard that lacks

1) clearly-defined goals, 2) comprehensive system architecture, 3) long-range planning, 4) uniformity and coherence of system components (e.g., satellite and terrestrial), and 5) rigorous analyses and optimization, and ultimately failing to meet the maritime MTC requirements.

This paper is thus intended to help avoid these potential pitfalls in the upcoming VDES standardization. It presents a comprehensive maritime MTC architecture. The unique requirements and challenges are identified and individually addressed through a concrete system design, based on the recently allocated international VHF maritime mobile band, for short burst data services of maritime IoT. From the top-down, the design is built around a service-centric network platform via federated maritime resource management that makes it easier and securer to represent maritime service and application requirements so that software-defined network-based solutions can be deployed seamlessly across the terrestrial and satellite components of the maritime MTC infrastructure. From the bottom up, the radio access network encompasses three unique air interfaces with dedicated frequency bands on the VHF spectrum to achieve distinct goals and requirements. By leveraging the unified protocol structure and channelization concept, the proposed MTC system not only can balance its coverage, transmission latency, system overhead/spectral efficiency but can provide a maximally *unified* framework for 1) all air interfaces; 2) both FDD and TDD transmissions; and 3) supporting different mobile station categories and diverse applications.

ACKNOWLEDGMENT

The authors are grateful to Mr. Eric Wang (University of California in San Diego) for his role in data collection and analysis in this project. The authors would also like to thank Miss Tingting Xia and Mr. Lei Wang for their help in writing this paper.

REFERENCES

- [1] *Strategy for the Development and Implementation of E-Navigation*, document MSC 85/26/Add.1 Annex 20, IMO, London, U.K., 2008.
- [2] T. Xia, M. M. Wang, and X. You, "Satellite machine-type communication for maritime Internet of Things: An interference perspective," *IEEE Access*, vol. 7, pp. 76404–76415, 2019.
- [3] T. Xia, M. M. Wang, J. Zhang, and L. Wang, "Maritime Internet of Things: Challenges and solutions," *IEEE Wireless Commun.*, vol. 27, no. 2, pp. 188–196, Apr. 2020.
- [4] J. Zhang, M. M. Wang, T. Xia, and L. Wang, "Maritime IoT: An architectural and radio spectrum perspective," *IEEE Access*, vol. 8, pp. 93109–93122, 2020.
- [5] M. Agiwal, A. Roy, and N. Saxena, "Next generation 5G wireless networks: A comprehensive survey," *IEEE Commun. Surveys Tuts.*, vol. 18, no. 3, pp. 1617–1655, 3rd Quart., 2016.
- [6] M. Cho, H. R. Choi, and C. Kwak, "A Study on the method of IoT-based navigation aids management," *Adv. Sci. Technol. Lett.*, vol. 98, pp. 55–58, Jun. 2015.
- [7] *Digital Selective-Calling System for Use in the Maritime Mobile Service*, document ITU-R M.493-15, ITU, Geneva, Switzerland, Jan. 2019.
- [8] *Technical Characteristics for an Automatic Identification System Using Time Division Multiple Access in the VHF Maritime Mobile Frequency Band*, document ITU-R M.1371-5, ITU, Geneva, Switzerland, Feb. 2014.
- [9] *MGN 324 (M+F), Radio: Operational Guidance on the Use of VHF Radio and Automatic Identification Systems (AIS) at Sea*, Gov.U.K., Maritime Coastguard Agency, London, U.K., Feb. 2015.
- [10] *International Convention for the Safety of Life at Sea (SOLAS)*, IMO, London, U.K., Apr. 2013.
- [11] Ø. J. Rødseth and B. Kvamstad, "Digital communication bandwidth requirements for future e-Navigation services," *Eur. J. Navig.*, vol. 7, no. 1, pp. 10–23, Apr. 2009.
- [12] "Automatic identification system VHF data link loading," Rep. ITU-R M.2287-0, ITU, Geneva, Switzerland, Dec. 2013.
- [13] *IALA Guideline G1117—VHF Data Exchange System (VDES) Overview, Ed. 2.0*, IALA, Paris, France, Dec. 2017.
- [14] S. Bober, "Paper 42—AIS next generation—The development of the VHF data exchange system (VDES) for maritime and inland navigation," in *Proc. Smart Rivers Conf.*, Buenos Aires, Argentina, Sep. 2015, pp. 1–8.
- [15] *Characteristics of VHF Radio Systems and Equipment for the Exchange of Data and Electronic Mail in the Maritime Mobile Service RR Appendix 18 Channel*, document ITU-R M.1842-1, ITU, Geneva, Switzerland, 2008-2009.
- [16] *Demonstration Objectives in Support of the Development of VDES, Fe-NAV14-17.3.1.6*, E-Navig. Committee, London, U.K., Sep. 2013.
- [17] *VDES Channel Sounding Campaign, PRT-09JSA-14, v.1.1*, Gen. Lighthouse Authorities, London, U.K., Apr. 2014.
- [18] *Technical Characteristics for a VHF Data Exchange System in the VHF Maritime Mobile Band*, document ITU-R M.2092-0, ITU, Geneva, Switzerland, Oct. 2015.
- [19] *Joint IMO/IHO/WMO Manual on Maritime Safety Information (MSI)*, Int. Hydrograph. Org., Quai Antoine 1er, Monaco, Jan. 2016.
- [20] T. Wahl, G. Høy, A. Lyngvi, and B. Narheim, "New possible roles of small satellites in maritime surveillance," *Acta Astronautica*, vol. 1, no. 56, pp. 273–277, Jan. 2005.
- [21] *Development of Short Sea Shipping*. Accessed: Feb. 2007. [Online]. Available: <https://www.transportation.gov/testimony/development-short-sea-shipping>
- [22] T. Eriksen, L. E. Braten, H. C. Haugli, and F. A. S. Storesund, "VDE-SAT—A new maritime communication system," in *Proc. 45 Symp.*, Valletta, Malta, Jun. 2016, pp. 1–12.
- [23] H. Haugli and L. Loge, "The VHF data exchange system (VDES) and NorSat-2 satellite testing," in *Proc. 35th AIAA Int. Commun. Satellite Syst. Conf. (ICSSIC)*, Trieste, Italy, Oct. 2017, pp. 202–208.
- [24] T. Eriksen *et al.*, "VDE-SAT – Preliminary verification results for proposed satellite component of new maritime communication system," in *Proc. 45 Symp.*, Sorrento, Italy, Jun. 2018, pp. 1–14.
- [25] L. M. Bradbury *et al.*, "NorSat-2: Enabling advanced maritime communication with VDES," *Acta Astronautica*, vol. 156, pp. 44–50, Mar. 2019.
- [26] Y. Ulybyshev, "Satellite constellation design for complex coverage," *J. Spacecraft Rockets*, vol. 45, no. 4, pp. 843–849, Jun. 2008.
- [27] *World Radiocommunication Conference (WRC-19) Provisional Final Acts*, ITU, Sharm El-Sheikh, Egypt, 2019.
- [28] *Resolution 360 (REV.WRC-15), Consideration of Regulatory Provisions and Spectrum Allocations to the Maritime Mobile-Satellite Service to Enable the Satellite Component of the VHF Data Exchange System and Enhanced Maritime Radiocommunication*, ITU, Geneva, Switzerland, 2015.
- [29] J. Šafář, C. Hargreaves, and N. Ward, "The VHF data exchange system," in *Proc. Antennas Propag. RF Technol. Transp. Auton. Platforms*, Birmingham, U.K., 2017, pp. 1–8.
- [30] "Technical studies on the satellite component of the VHF data exchange system," Rep. ITU-R M.2435-0, ITU, Geneva, Switzerland, Nov. 2018.
- [31] *Assignment and Use of Identities in the Maritime Mobile Service*, document ITU-R M.585-7, ITU, Geneva, Switzerland, May 2015.
- [32] *IALA Guideline 1082—An Overview of AIS Ed. 1.0*, IALA, Paris, France, Jun. 2011.
- [33] A. Bole, A. Wall, and A. Norris, *Rader and APPA Manual Chapter 5: Automatic Identification System (AIS)*, 3rd ed. Amsterdam, The Netherlands: Elsevier, 2014, pp. 255–275.
- [34] *Resolution A. 917(22) Guidelines for the Onboard Operational Use of Shipborne Automatic Identification Systems (AIS)*, IMO, London, U.K., Nov. 2001.
- [35] *Resolution A. 1106(29) Revised Guidelines for the Onboard Operational Use of Shipborne Automatic Identification Systems (AIS)*, IMO, London, U.K., Dec. 2016.
- [36] *Satellite Detection of Automatic Identification System Messages*, document ITU-R M.2084, ITU, Geneva, Switzerland, 2006.
- [37] "Improved satellite detection of AIS," Rep. ITU-R M.2169, ITU, Geneva, Switzerland, 2009.
- [38] W. Yang *et al.*, "Narrowband wireless access for low-power massive Internet of Things: A bandwidth perspective," *IEEE Wireless Commun.*, vol. 24, no. 3, pp. 138–145, Jun. 2017.

- [39] P. Frenger, S. Parkvall, and E. Dahlman, "Performance comparison of HARQ with Chase combining and incremental redundancy for HSDPA," in *Proc. IEEE 54th Veh. Technol. Conf.*, vol. 3. Atlantic City, NJ, USA, 2001, pp. 1829–1833.
- [40] *Method for Point-to-Area Predictions for Terrestrial Services in the Frequency Range 30 MHz to 3000 MHz*, document ITU-R P.1546-5, ITU, Geneva, Switzerland, Sep. 2013.



Michael Mao Wang received the bachelor's and master's degrees in electrical engineering from Southeast University, and the master's degree in biomedical engineering and the Ph.D. degree in electrical and computer engineering from the University of Kentucky, Lexington, KY, USA. He was a Distinguished Member of Technical Staff with Motorola Advanced Radio Technology Group, Arlington Heights, IL, USA, from 1995 to 2003. He joined Qualcomm Research, San Diego, CA, USA, in 2003, and he later became a Professor

with the School of Information Science and Technology and the National Mobile Communications Research Laboratory, Southeast University in 2015. In addition to his faculty appointment with Southeast University, he holds an Adjunct Professor appointment with the Nanjing University of Science and Technology. He has over 40 IEEE journal publications and holds more than 90 U.S. patents. His research interests include communication theory and wireless networking.

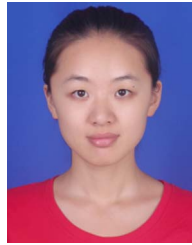

Jingjing Zhang received the Ph.D. degree from the School of Electronic and Optical Engineering, Nanjing University of Science and Technology, China, in 2019. She is currently with the School of Internet of Things, Nanjing University of Posts and Telecommunications, China. She has over ten IEEE journal publications. Her current research interests are in the areas of wireless communications and signal processing.



Xiaohu You (Fellow, IEEE) received the Ph.D. degree in electrical engineering from Southeast University, Nanjing, China, in 1988. Since 1990, he has been working with the National Mobile Communications Research Laboratory, Southeast University, where he is currently the Director. He was the Premier Foundation Investigator of the China National Science Foundation. From 1999 to 2002, he was the Principal Expert of the C3G Project, responsible for organizing China's 3G mobile communications Research and Development activities. From 2001 to 2006, he was the Principal Expert of the National 863 Beyond 3G FUTURE Project. From 2013 to 2019, he was the Principal Investigator of China National 863 5G Project. He has contributed over 100 IEEE journal papers and three books in the areas of signal processing, artificial neural networks, and wireless communication systems. He served as the General Chair of IEEE WCNC 2013, IEEE VTC 2016 and IEEE ICC 2019. He is currently the Secretary General of the FuTURE Forum, the Vice Chair of China IMT-2020 Promotion Group and China National Mega Project on New Generation Mobile Network. He was the recipient of the National 1st Class Invention Prize in 2011, and he was selected as IEEE Fellow in 2011.